

# Natural Language Processing

Last update: 17 December 2024

Academic Year 2024 – 2025  
Alma Mater Studiorum · University of Bologna

# Contents

<b>1. Basic text processing</b>	<b>1</b>
1.1. Regular expressions . . . . .	1
1.1.1. Basic operators . . . . .	1
1.2. Tokenization . . . . .	2
1.2.1. Data-driven tokenization . . . . .	3
1.3. Normalization . . . . .	4
1.4. Edit distance . . . . .	5
<b>2. Language models</b>	<b>6</b>
2.1. Spelling correction . . . . .	6
2.2. Language models . . . . .	8
2.3. Metrics . . . . .	9
2.3.1. Extrinsic evaluation . . . . .	9
2.3.2. Intrinsic evaluation . . . . .	9
2.4. N-gram model problems . . . . .	10
2.4.1. Overfitting . . . . .	10
2.4.2. Out-of-vocabulary tokens . . . . .	10
2.4.3. Unseen sequences . . . . .	10
<b>3. Text classification</b>	<b>12</b>
3.1. Common tasks . . . . .	12
3.2. Classification . . . . .	12
3.3. Naive Bayes . . . . .	12
3.3.1. Optimizations . . . . .	14
3.3.2. Properties . . . . .	15
3.4. Logistic regression . . . . .	15
3.4.1. Properties . . . . .	16
3.5. Metrics . . . . .	16
3.5.1. Binary classification . . . . .	16
3.5.2. Multi-class classification . . . . .	16
3.5.3. Cross-validation . . . . .	17
3.5.4. Statistical significance . . . . .	17
3.6. Affective meaning . . . . .	18
3.6.1. Emotion . . . . .	19
<b>4. Semantics embedding</b>	<b>20</b>
4.1. Traditional semantic representation . . . . .	20
4.1.1. Sense relations . . . . .	20
4.1.2. Common ontologies . . . . .	20
4.1.3. Word relations . . . . .	20
4.2. Vector semantics . . . . .	21
4.2.1. Sparse embeddings . . . . .	21
4.2.2. Dense non-contextual embeddings . . . . .	24

4.3.	Embeddings properties . . . . .	27
4.3.1.	Embeddings similarity . . . . .	27
4.3.2.	Embeddings analysis . . . . .	28
<b>5.</b>	<b>Recurrent neural networks</b>	<b>30</b>
5.1.	Architectures . . . . .	30
5.1.1.	(Elman) recurrent neural network . . . . .	30
5.1.2.	Long short-term memory . . . . .	31
5.1.3.	Gated recurrent units . . . . .	32
5.1.4.	Bidirectional RNN . . . . .	32
5.1.5.	Stacked multi-layer RNN . . . . .	33
5.2.	Applications . . . . .	33
<b>6.</b>	<b>Attention-based architectures</b>	<b>35</b>
6.1.	Encoder-decoder RNN with attention . . . . .	35
6.2.	Convolutional neural networks for NLP . . . . .	36
6.3.	Transformer decoder (for language modelling) . . . . .	37
6.3.1.	Self-attention . . . . .	37
6.3.2.	Embeddings . . . . .	38
6.3.3.	Transformer block . . . . .	39
<b>7.</b>	<b>Large language models</b>	<b>41</b>
7.1.	Decoder-only architecture . . . . .	41
7.1.1.	Decoding strategies . . . . .	41
7.1.2.	Pre-training . . . . .	43
7.1.3.	Fine-tuning . . . . .	43
7.2.	Encoder-only architecture . . . . .	44
7.2.1.	Pre-training . . . . .	44
7.2.2.	Fine-tuning . . . . .	45
7.3.	Encoder-decoder architecture . . . . .	46
7.3.1.	Pre-training . . . . .	46
<b>8.</b>	<b>Efficient model utilization</b>	<b>47</b>
8.1.	Low-rank adaptation . . . . .	47
8.2.	Model compression . . . . .	47
8.2.1.	Parameters compression . . . . .	47
8.2.2.	Training compression . . . . .	47
8.3.	In-context learning . . . . .	48
<b>9.</b>	<b>Language model alignment and applications</b>	<b>50</b>
9.1.	Model alignment . . . . .	50
9.1.1.	Instruction tuning . . . . .	50
9.1.2.	Preference alignment . . . . .	51
<b>10.</b>	<b>Retrieval augmented generation (RAG)</b>	<b>52</b>
10.1.	Information retrieval . . . . .	52
10.1.1.	Document embeddings . . . . .	52
10.1.2.	Metrics . . . . .	54
10.2.	Question answering . . . . .	55
10.2.1.	Reading comprehension task . . . . .	55

10.2.2. Metrics . . . . .	56
10.2.3. Retrieval-augmented generation for question answering . . . . .	56
<b>A. Task-oriented dialog systems</b>	<b>58</b>
A.1. Human dialogs . . . . .	58
A.2. Task-oriented dialogs . . . . .	58
A.2.1. Architectures . . . . .	58
A.2.2. Dataset . . . . .	59
A.3. Research topics . . . . .	60
A.3.1. LLM domain portability . . . . .	60
A.3.2. LLM pragmatics . . . . .	60
A.3.3. LLM for dialog generation . . . . .	60
<b>B. Speech processing</b>	<b>61</b>
B.1. Audio representation . . . . .	61
B.2. Tasks . . . . .	62
B.3. Speech foundation models . . . . .	63
<b>C. Italian LLMs</b>	<b>64</b>

# 1. Basic text processing

**Text normalization** Operations such as:

**Tokenization** Split a sentence in tokens.

Tokenization

| **Remark.** Depending on the approach, a token is not always a word.

**Lemmatization/stemming** Convert words to their canonical form.

Lemmatization/stemming

| **Example.** {sang, sung, sings}  $\mapsto$  sing

**Sentence segmentation** Split a text in sentences.

Sentence segmentation

| **Remark.** A period does not always signal the end of a sentence.

## 1.1. Regular expressions

**Regular expression (regex)** Formal language to describe string patterns.

Regular expression (regex)

### 1.1.1. Basic operators

**Disjunction (brackets)** Match a single character between square brackets [].

| **Example.** /[wW]oodchuck/ matches Woodchuck and woodchuck.

**Range** Match a single character from a range of characters or digits.

**Example.**

- /[A-Z]/ matches a single upper case letter.
- /[a-z]/ matches a single lower case letter.
- /[0-9]/ matches a single digit.

**Negation** Match the negation of a pattern.

| **Example.** /^[^A-Z]/ matches a single character that is not an upper case letter.

**Disjunction (pipe)** Disjunction of regular expressions separated by |.

| **Example.** /groundhog|woodchuck/ matches groundhog and woodchuck.

### Wildcards

**Optional** A character followed by ? can be matched optionally.

| **Example.** /woodchucks?/ matches woodchuck and woodchucks.

**Any** . matches any character.

**Kleene \*** A character followed by \* can be matched zero or more times.

**Kleene +** A character followed by + must be matched at least once.

**Counting** A character followed by {n,m} must be matched from n to m times.

### Example.

- `{n}` matches exactly  $n$  instances of the previous character.
- `{n,m}` matches from  $n$  to  $m$  instances of the previous character.
- `{n,}` matches at least  $n$  instances of the previous character.
- `{,m}` matches at most  $m$  instances of the previous character.

### Anchors

**Start of line** `^` matches only at the start of line.

| **Example.** `/^a/` matches a but not ba.

**End of line** `$` matches only at the end of line.

| **Example.** `/a$/` matches a but not ab.

**Word boundary** `\b` matches a word boundary character.

**Word non-boundary** `\B` matches a word non-boundary character.

### Aliases

- `\d` matches a single digit (same as `[0-9]`).
- `\D` matches a single non-digit (same as `[^\d]`).
- `\w` matches a single alphanumeric or underscore character (same as `[a-zA-Z0-9_]`).
- `\W` matches a single non-alphanumeric and non-underscore character (same as `[^\w]`).
- `\s` matches a single whitespace (space or tab).
- `\S` matches a single non-whitespace.

**Capture group** Operator to refer to previously matched substrings.

| **Example.** In the regex:

```
/the (.*?)er they were, the \1er they will be/
```

| `\1` should match the same content matched by `(.*)`.

## 1.2. Tokenization

**Lemma** Words with the same stem and roughly the same semantic meaning.

Lemma

| **Example.** `cat` and `cats` are the same lemma.

**Wordform** Orthographic appearance of a word.

Wordform

| **Example.** `cat` and `cats` do not have the same wordform.

**Vocabulary** Collection of text elements, each indexed by an integer.

Vocabulary

| **Remark.** To reduce the size of a vocabulary, words can be reduced to lemmas.

**Type / Wordtype** Element of a vocabulary (i.e., wordforms in the vocabulary).

Type / Wordtype

**Token** Instance of a type in a text.

Token

**Genre** Topic of a text corpus (e.g., short social media comments, books, Wikipedia pages, ...).

Genre

**Remark** (Herdan’s law). Given a corpus with  $N$  tokens, a vocabulary  $V$  over that corpus roughly have size:

$$|V| = kN^\beta$$

where the typical values are  $10 \leq k \leq 100$  and  $0.4 \leq \beta \leq 0.6$ .

**Stopwords** Frequent words that can be dropped.

Stopwords

**Remark.** If semantics is important, stopwords should be kept. LLMs keep stopwords.

**Rule-based tokenization** Hand-defined rules for tokenization.

Rule-based tokenization

**Remark.** For speed, simple tokenizers use regex.

**Data-driven tokenization** Determine frequent tokens from a large text corpus.

Data-driven tokenization

### 1.2.1. Data-driven tokenization

Tokenization is done by two components:

**Token learner** Learns a vocabulary from a given corpus (i.e., training).

Token learner

**Token segmenter** Segments a given input into tokens based on a vocabulary (i.e., inference).

Token segmenter

**Byte-pair encoding (BPE)** Based on the most frequent  $n$ -grams.

Byte-pair encoding (BPE)

**Token learner** Given a training corpus  $C$ , BPE determines the vocabulary as follows:

1. Start with a vocabulary  $V$  containing all the 1-grams of  $C$  and an empty set of merge rules  $M$ .
2. Until the desired size of the vocabulary is reached:
  - a) Determine the pair of tokens  $t_1 \in V$  and  $t_2 \in V$  such that, among all the possible pairs, the  $n$ -gram  $t_1 + t_2 = t_1t_2$  obtained by merging them is the most frequent in the corpus  $C$ .
  - b) Add  $t_1t_2$  to  $V$  and the merge rule  $t_1 + t_2$  to  $M$ .

**Example.** Given the following corpus:

Occurrences	Tokens
5	l o w \$
2	l o w e r \$
6	n e w e s t \$
6	w i d e s t \$

The initial vocabulary is:  $V = \{\$, l, o, w, e, r, n, w, s, t, i, d\}$ .

At the first iteration,  $e + s = es$  is the most frequent  $n$ -gram. Corpus and vocabulary are updated as:

Occurrences	Tokens
5	l o w \$
2	l o w e r \$
6	n e w e s t \$
6	w i d e s t \$

$$V = \{\$, l, o, w, e, r, n, w, s, t, i, d\} \cup \{es\}$$

At the second iteration,  $es + t = est$  is the most frequent  $n$ -gram:

Occurrences	Tokens
5	l o w \$
2	l o w e r \$
6	n e w e s t \$
6	w i d e s t \$

$$V = \{\$, l, o, w, e, r, n, w, s, t, i, d, es\} \cup \{est\}$$

And so on...

**Token segmenter** Given the vocabulary  $V$  and the merge rules  $M$ , the BPE segmenter does the following:

1. Split the input into 1-grams.
2. Iteratively scan the input and do the following:
  - a) Apply a merge rule if possible.
  - b) If no merge rules can be applied, lookup the (sub)word in the vocabulary. Tokens out-of-vocabulary are marked with a special unknown token [UNK].

**WordPiece** Similar to BPE with the addition of merge rules ranking and a special leading/tailing set of characters (usually ##) to identify subwords (e.g., new##, ##est are possible tokens).

WordPiece

**Unigram tokenization** Starts with a big vocabulary and remove tokens following a loss function.

Unigram tokenization

## 1.3. Normalization

**Normalization** Convert tokens into a standard form.

Normalization

| **Example.** U.S.A. and USA should be encoded using the same index.

**Case folding** Map every token to upper/lower case.

Case folding

| **Remark.** Depending on the task, casing might be important (e.g., US vs us).

**Lemmatization** Reduce inflections and variant forms to their base form.

Lemmatization

| **Example.** {am, are, is}  $\mapsto$  be

| **Remark.** Accurate lemmatization requires complete morphological parsing.

**Stemming** Reduce terms to their stem.

Stemming

| **Remark.** Stemming is a simpler approach than lemmatization.

**Porter stemmer** Simple stemmer based on cascading rewrite rules.

| **Example.** ational  $\mapsto$  ate, ing  $\mapsto$   $\varepsilon$ , sses  $\mapsto$  ss.



## 1.4. Edit distance

**Minimum edit distance** Minimum number of edit operations (insertions, deletions, and substitutions) needed to transform a string into another one.

Minimum edit distance

**Remark.** Dynamic programming can be used to efficiently determine the minimum edit distance.

**Levenshtein distance** Minimum edit distance where:

Levenshtein distance

- Insertions cost 1,
- Deletions cost 1,
- Substitutions cost 2.

**Example.** The Levenshtein distance between `intention` and `execution` is 8.

I	N	T	E	*	N	T	I	O	N
*	E	X	E	C	U	T	I	O	N
-	±	±		+	±				
1	2	2		1	2				

## 2. Language models

### 2.1. Spelling correction

**Spelling correction** Spelling errors can be of two types:

Spelling correction

**Non-word spelling** Typos that result in non-existing words. Possible candidates can be determined through a dictionary lookup.

**Real-word spelling** Can be:

**Typographical error** Typos that result in existing words.

**Cognitive error** Due to words similarity (e.g., *piece* vs *peace*).

**Noisy channel model** Assumes that the observable input is a distorted form of the original word. A decoder tests word hypotheses and selects the best match.

Noisy channel model

More formally, we want a model of the channel that, similarly to Bayesian inference, determines the likelihood that a word  $w \in V$  is the original word for a noisy one  $x$ . From there, we can estimate the correct word  $\hat{w}$ :

$$\hat{w} = \arg \max_{w \in V} \mathcal{P}(w|x)$$

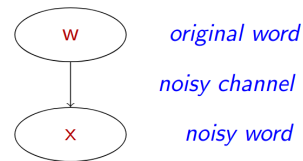

By applying (i) Bayes' rule, (ii) the fact that  $\hat{w}$  is independent of  $\mathcal{P}(x)$ , and (iii) that a subset  $C \subseteq V$  of the vocabulary can be used, the estimate becomes:

$$\hat{w} = \arg \max_{w \in C} \underbrace{\mathcal{P}(x|w)}_{\text{channel model}} \underbrace{\mathcal{P}(w)}_{\text{prior}}$$

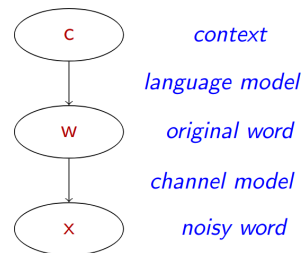

Moreover, it is reasonable to include a context  $c$  when computing the prior:

$$\hat{w} = \arg \max_{w \in C} \underbrace{\mathcal{P}(x|w)}_{\text{channel model}} \underbrace{\mathcal{P}(w|c)}_{\text{language model}}$$

**Noisy channel spelling method** Spelling correction in a noisy channel model can be done as follows:

1. Find candidate words with similar spelling to the input based on a distance metric (e.g., Damerau-Levenshtein which is the Levenshtein distance with the addition of adjacent transpositions).
2. Score each candidate based on the language and channel model:
  - Use typing features of the user.
  - Use local context.
  - Use a confusion matrix with common mistakes.

**Example.** Consider the sentence:

[...] *was called a “stellar and versatile **actress** whose combination of sass and glamour has defined her [...]”*

By using the Corpus of Contemporary American English (COCA), we can determine the following words as candidates:

**actress · cress · caress · access · across · acres**

**Language model** By considering a language model without context, the priors are computed as  $\mathcal{P}(w|\emptyset) = \frac{\text{count}(w)}{|\text{COCA}|}$  (where  $|\text{COCA}| = 404\,253\,213$ ):

$w$	$\text{count}(w)$	$\mathcal{P}(w \emptyset)$
<b>actress</b>	9321	0.0000231
<b>cress</b>	220	0.00000544
<b>caress</b>	686	0.0000170
<b>access</b>	37038	0.0000916
<b>across</b>	120844	0.000299
<b>acres</b>	12874	0.0000318

**Channel model** By using a confusion matrix of common typos, the channel model is:

$w$	$x w$	$\mathcal{P}(x w)$
<b>actress</b>	c ct	0.000117
<b>cress</b>	a #	0.00000144
<b>caress</b>	ac ca	0.00000164
<b>access</b>	r c	0.000000209
<b>across</b>	e o	0.0000093
<b>acres</b>	es e	0.0000321
<b>acres</b>	ss s	0.0000342

The ranking is the obtained as:

$w$	$\mathcal{P}(x w)\mathcal{P}(w \emptyset)$
<b>actress</b>	$2.7 \cdot 10^{-9}$
<b>cress</b>	$0.00078 \cdot 10^{-9}$
<b>caress</b>	$0.0028 \cdot 10^{-9}$
<b>access</b>	$0.019 \cdot 10^{-9}$
<b>across</b>	$2.8 \cdot 10^{-9}$
<b>acres</b>	$1.02 \cdot 10^{-9}$
<b>acres</b>	$1.09 \cdot 10^{-9}$

Therefore, the most likely correction of **actress** for this model is **across**.

If the previous word is considered in the context, the relevant tokens of the new language model are:

$w_{i-1}$	$w_i$	$\mathcal{P}(w_i w_{i-1})$
<b>versatile</b>	<b>actress</b>	0.000021
<b>versatile</b>	<b>across</b>	0.000021
<b>actress</b>	<b>whose</b>	0.001
<b>across</b>	<b>whose</b>	0.000006

This allows to measure the likelihood of a word within its context as:

$$\mathcal{P}(\text{versatile } \underline{\text{actress}} \text{ whose}) = \mathcal{P}(\text{actress}|\text{versatile})\mathcal{P}(\text{whose}|\text{actress}) = 210 \cdot 10^{-10}$$

$$\mathcal{P}(\text{versatile } \underline{\text{across}} \text{ whose}) = \mathcal{P}(\text{across}|\text{versatile})\mathcal{P}(\text{whose}|\text{across}) = 1 \cdot 10^{-10}$$

Finally, we have that:

$$\mathcal{P}(\text{versatile } \underline{\text{actress}} \text{ whose}|\text{versatile } \text{acress} \text{ whose}) = (2.7 \cdot 10^{-9}) \cdot (210 \cdot 10^{-10})$$

$$\mathcal{P}(\text{versatile } \underline{\text{across}} \text{ whose}|\text{versatile } \text{acress} \text{ whose}) = (2.8 \cdot 10^{-9}) \cdot (1 \cdot 10^{-10})$$

So **actress** is the most likely correction for **acress** in this model.

**Remark.** In practice, log-probabilities are used to avoid underflows and to make computation faster (i.e., sums instead of products).

## 2.2. Language models

**(Probabilistic) language model** Model to determine the probability of a word  $w$  in a given context  $c$ : Language model

$$\mathcal{P}(w|c)$$

Usually, it is based on counting statistics and uses as context the sequence of previous tokens:

$$\mathcal{P}(w_i|w_1, \dots, w_{i-1})$$

This is equivalent to computing the probability of the whole sentence, which expanded using the chain rule becomes:

$$\begin{aligned} \mathcal{P}(w_1, \dots, w_{i-1}w_i) &= \mathcal{P}(w_1)\mathcal{P}(w_2|w_1)\mathcal{P}(w_3|w_{1..2}) \dots \mathcal{P}(w_n|w_{1..n-1}) \\ &= \prod_{i=1}^n \mathcal{P}(w_i|w_{1..i-1}) \end{aligned}$$

**Remark.** Simply counting the number of occurrences of a sentence as  $\mathcal{P}(w_i|w_{1..i-1}) = w_{1..i}/w_{1..i-1}$  is not ideal as there are too many possible sentences.

**Markov assumption** Limit the length of the context to a window of  $k$  previous tokens: Markov assumption in language models

$$\mathcal{P}(w_i|w_{1..i-1}) \approx \mathcal{P}(w_i|w_{i-k..i-1})$$

$$\mathcal{P}(w_{1..n}) \approx \prod_{i=1}^n \mathcal{P}(w_i|w_{i-k..i-1})$$

**Unigram model** Model without context ( $k = 0$ ):

$$\mathcal{P}(w_{1..n}) \approx \prod_i \mathcal{P}(w_i)$$

**Bigram model** Model with a single token context ( $k = 1$ ):

$$\mathcal{P}(w_{1..n}) \approx \prod_i \mathcal{P}(w_i|w_{i-1})$$

**N-gram model** Model with a context of  $k = N - 1$  tokens: N-gram model

$$\mathcal{P}(w_{1..n}) \approx \prod_i \mathcal{P}(w_i|w_{i-N+1..i-1})$$

| **Remark.**  $N$ -gram models cannot capture long-range dependencies.

**Estimating  $N$ -gram probabilities** Consider the bigram case, the probability that a token  $w_i$  follows  $w_{i-1}$  can be determined through counting:

$$\mathcal{P}(w_i|w_{i-1}) = \frac{\text{count}(w_{i-1}w_i)}{\text{count}(w_{i-1})}$$

| **Remark.**  $N$ -gram models cannot handle unknown tokens.

| **Remark.**  $N$ -gram models capture knowledge about:

- Grammar and syntax.
- Some information about the dataset (e.g., domain, genre of corpus, cultural aspects, ...).

**Generation by sampling** Randomly sample tokens from the distribution of a language model.

Generation by sampling

| **Remark.** In  $N$ -gram models ( $N \geq 2$ ), the distribution changes depending on the previously sampled tokens.

## 2.3. Metrics

### 2.3.1. Extrinsic evaluation

**Extrinsic/downstream evaluation** Compare the performance of different models on specific tasks.

Extrinsic evaluation

| **Remark.** Extrinsic evaluation is the best approach for comparing different models, but it is often computationally expensive.

### 2.3.2. Intrinsic evaluation

**Intrinsic evaluation** Measure the quality of a model independently of the task.

Intrinsic evaluation

**Perplexity (PP)** Probability-based metric based on the inverse probability of a sequence (usually using the test set) normalized by the number of words:

Perplexity

$$\mathcal{P}(w_{1..N}) = \prod_i \mathcal{P}(w_i|w_{1..i-1})$$
$$\text{PP}(w_{1..N}) = \mathcal{P}(w_{1..N})^{-\frac{1}{N}} \in [1, +\infty]$$

Generally, a lower perplexity represents a better model.

| **Example.** For bigram models, perplexity is computed as:

$$\mathcal{P}(w_{1..N}) \approx \prod_i \mathcal{P}(w_i|w_{i-1}) \quad \text{PP}(w_{1..N}) = \sqrt[N]{\prod_i \frac{1}{\mathcal{P}(w_i|w_{i-1})}}$$

| **Remark** (Perplexity intuition). Perplexity can be seen as a measure of surprise of a language model when evaluating a sequence.

Alternatively, it can also be seen as a weighted average branching factor (i.e., average number of possible unique next words that follow any word accounting for their probabilities). For instance, consider a vocabulary of digits and a training corpus where every digit appears with uniform probability 0.1. The perplexity of any

sequence using a 1-gram model is:

$$PP(w_{1..N}) = (0.1^N)^{-\frac{1}{N}} = 10$$

Now consider a training corpus where 0 occurs 91% of the time and the other digits 1% of the time. The perplexity of the sequence 0 0 0 0 0 3 0 0 0 0 is:

$$PP(0\ 0\ 0\ 0\ 0\ 3\ 0\ 0\ 0\ 0) = (0.91^9 \cdot 0.01)^{-\frac{1}{10}} \approx 1.73$$

**Remark.** Minimizing perplexity is the same as maximizing the probability of the tokens.

**Remark.** Perplexity can be artificially reduced by using a smaller vocabulary. Therefore, it is only reasonable to compare perplexity of models with the same vocabulary.

**Remark.** Perplexity is generally a bad approximation of extrinsic metrics and only works well if the test set is representative of the training data. Therefore, it is only useful to guide experiments and the final evaluation should be done through extrinsic evaluation.

## 2.4. N-gram model problems

### 2.4.1. Overfitting

$N$ -gram models become better at modeling the training corpus for increasing values of  $N$ . This risks overfitting and does not allow to obtain a generalized model. Overfitting

**Example.** A 4-gram model is able to nearly perfectly generate sentences from Shakespeare's works.

### 2.4.2. Out-of-vocabulary tokens

There are two types of vocabulary systems:

**Closed vocabulary system** All words that can occur are known. Closed vocabulary

**Open vocabulary system** Unknown words are possible. They are usually handled using a dedicated token <UNK> which allows to turn an open vocabulary system into a closed one: Open vocabulary

- Use a vocabulary and model all other words as <UNK>.
- Model infrequent words as <UNK>.

**Remark.** The training set must contain <UNK> tokens to estimate its distribution as it is treated as any other token.

### 2.4.3. Unseen sequences

Only for  $n$ -grams that occur enough times a representative probability can be estimated. For increasing values of  $n$ , the sparsity grows causing many unseen  $n$ -grams that produce a probability of 0, with the risk of performing divisions by zero (e.g., when computing perplexity) or zeroing probabilities (e.g., when applying the chain rule).

**Laplace smoothing** Adds 1 to all counts and renormalizes them. Given a vocabulary  $V$  and an  $N$ -gram model, smoothing is done as follows: Laplace smoothing

$$\mathcal{P}_{\text{Laplace}}(w_i | w_{i-N+1..i-1}) = \frac{\text{count}(w_{i-N+1..i-1}w_i) + 1}{\text{count}(w_{i-N+1..i-1}) + |V|}$$

Alternatively, by only changing the numerator, it can be formulated using an adjusted count as:

$$\mathcal{P}_{\text{Laplace}}(w_i | w_{i-N+1..i-1}) = \frac{c^*}{\text{count}(w_{i-N+1..i-1})}$$

$$c^* = (\text{count}(w_{i-N+1..i-1}w_i) + 1) \frac{\text{count}(w_{i-N+1..i-1})}{\text{count}(w_{i-N+1..i-1}) + |V|}$$

where  $\frac{\text{count}(w_{i-N+1..i-1})}{\text{count}(w_{i-N+1..i-1}) + |V|}$  is a normalization factor.

**Example.** For a 2-gram model, Laplace smoothing is computed as:

$$\mathcal{P}_{\text{Laplace}}(w_i | w_{i-1}) = \frac{\text{count}(w_{i-1}w_i) + 1}{\text{count}(w_{i-1}) + |V|}$$

Or by using the adjusted count as:

$$\mathcal{P}_{\text{Laplace}}(w_i | w_{i-1}) = \frac{c^*}{\text{count}(w_{i-1})} \quad c^* = (\text{count}(w_{i-1}w_i) + 1) \frac{\text{count}(w_{i-1})}{\text{count}(w_{i-1}) + |V|}$$

## 3. Text classification

### 3.1. Common tasks

**Sentiment analysis/Opinion mining** Detection of attitudes. It can involve detecting:

- The holder of attitude (i.e., the source).
- The target of attitude (i.e., the aspect).
- The type of attitude (e.g., positive or negative).
- The text containing the attitude.

Sentiment analysis/Opinion mining

**Spam detection**

**Language identification**

**Authorship attribution**

**Subject category classification**

### 3.2. Classification

**Classification task** Given an input  $x$  and a set of possible classes  $Y = \{y_1, \dots, y_M\}$ , a classifier determines the class  $\hat{y} \in Y$  associated to  $x$ .

Classification task

Classification can be:

**Rule-based** Based on fixed (possibly handwritten) rules.

Rule-based

| **Example.** Blacklist, whitelist, regex, ...

**In-context learning** Provide a decoder (i.e., generative) large language model a prompt describing the task and the possible classes.

In-context learning

| **Example.** Zero-shot learning, few-shot learning, ...

**Supervised machine learning** Use a training set of  $N$  labeled document-class data points  $\{(d_i, c_i)\}$  to fit a classifier.

Supervised machine learning

An ML model can be:

**Generative** Informally, it learns the distribution of the data (i.e.,  $\mathcal{P}(d_i|c_i)$ ).

**Discriminative** Informally, it learns to exploit the features to determine the class (i.e.,  $\mathcal{P}(c_i|d_i)$ ).

### 3.3. Naive Bayes

**Bag-of-words (BoW)** Representation of a document using the frequency of its words.

Bag-of-words (BoW)

Given a vocabulary  $V$  and a document  $d$ , the bag-of-words embedding of  $d$  is a vector in  $\mathbb{N}^{|V|}$  where the  $i$ -th position contains the number of occurrences of the  $i$ -th token of  $V$  in  $d$ .



**Multinomial naive Bayes classifier** Generative probabilistic classifier based on the assumption that features are independent given the class.

Given a document  $d = \{w_1, \dots, w_n\}$ , a naive Bayes classifier returns the class  $\hat{c}$  with maximum posterior probability:

$$\begin{aligned} \hat{c} &= \arg \max_{c \in C} \mathcal{P}(c|d) \\ &= \arg \max_{c \in C} \underbrace{\mathcal{P}(d|c)}_{\text{likelihood}} \underbrace{\mathcal{P}(c)}_{\text{prior}} \\ &= \arg \max_{c \in C} \mathcal{P}(w_1, \dots, w_n|c) \mathcal{P}(c) \\ &\approx \arg \max_{c \in C} \prod_i \mathcal{P}(w_i|c) \mathcal{P}(c) \\ &= \arg \max_{c \in C} \sum_i \log \mathcal{P}(w_i|c) \log \mathcal{P}(c) \end{aligned}$$

Given a training set  $D$  and a vocabulary  $V$ ,  $\mathcal{P}(w_i|c)$  and  $\mathcal{P}(c)$  are determined during training by maximum likelihood estimation as follows:

$$\mathcal{P}(c) = \frac{N_c}{|D|} \quad \mathcal{P}(w_i|c) = \frac{\text{count}(w_i, c)}{\sum_{v \in V} \text{count}(v, c)}$$

where  $N_c$  is the number of documents of class  $c$  and  $\text{count}(w, c)$  counts the occurrences of the word  $w$  in the training samples of class  $c$ .

**Remark.** Laplace smoothing is used to avoid zero probabilities.

**Remark.** Stop words can be removed from the training set as they are usually not relevant.

**Remark.** The likelihood part of the equation ( $\sum_i \log \mathcal{P}(w_i|c)$ ) can be seen as a set of class-specific 1-gram language models.

**Example.** Given the following training set for sentiment analysis with two classes:

Class	Document
-	just plain boring
-	entirely predictable and lacks energy
-	no surprises and very few laughs
+	very powerful
+	the most fun film of the summer

We want to classify the sentence “predictable with no fun”. Excluding stop words (i.e., with), we need to compute:

$$\begin{aligned} \mathcal{P}(+|\text{predictable with no fun}) &= \mathcal{P}(+) \mathcal{P}(\text{predictable}|+) \mathcal{P}(\text{no}|+) \mathcal{P}(\text{fun}|+) \\ \mathcal{P}(-|\text{predictable with no fun}) &= \mathcal{P}(-) \mathcal{P}(\text{predictable}|-) \mathcal{P}(\text{no}|-) \mathcal{P}(\text{fun}|-) \end{aligned}$$

A vocabulary of 20 tokens can be used to represent the training samples. The required likelihoods and priors with Laplace smoothing are computed as:

$$\begin{aligned} \mathcal{P}(+) &= \frac{2}{5} & \mathcal{P}(\text{predictable}|+) &= \frac{0+1}{9+20} & \mathcal{P}(\text{no}|+) &= \frac{0+1}{9+20} & \mathcal{P}(\text{fun}|+) &= \frac{1+1}{9+20} \\ \mathcal{P}(-) &= \frac{3}{5} & \mathcal{P}(\text{predictable}|-) &= \frac{1+1}{14+20} & \mathcal{P}(\text{no}|-) &= \frac{1+1}{14+20} & \mathcal{P}(\text{fun}|-) &= \frac{0+1}{14+20} \end{aligned}$$

### 3.3.1. Optimizations

Possible optimizations for naive Bayes applied to sentiment analysis are the following:

**Binarization** Generally, the information regarding the occurrence of a word is more important than its frequency. Therefore, instead of applying bag-of-words by counting, it is possible to produce a one-hot encoded vector to indicate which words are in the document.

Binarization

**Negation encoding** To encode negations, two approaches can be taken:

Negation encoding

**Negation annotation** Add to negated words an annotation so that they are treated as a new word.

**Example.** Prepend NOT\_ to each word between a negation and the next punctuation:

didn't like this movie.  $\mapsto$  didn't NOT\_like NOT\_this NOT\_movie.

**Parse tree** Build a tree to encode the sentiment and interactions of the words. By propagating the sentiments bottom-up, it is possible to determine the overall sentiment of the sequence.

**Example.** The parse tree for the sentence “This film doesn't care about cleverness, wit or any other kind of intelligent humor.” is the following:

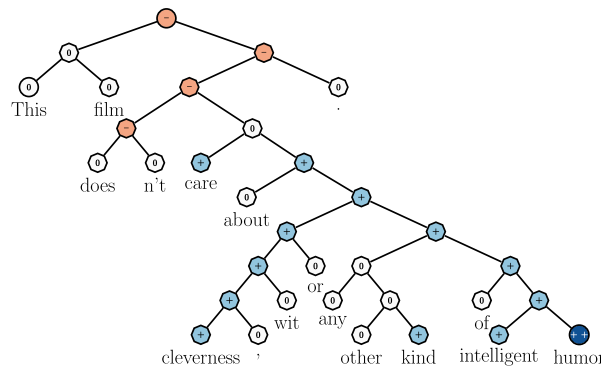

Due to the negation (**doesn't**), the whole positive sequence is negated.

**Sentiment lexicon** If training data is insufficient, external domain knowledge, such as sentiment lexicon, can be used.

Sentiment lexicon

**Example.** A possible way to use a lexicon is to count the number of positive and negative words according to that corpus.

**Remark.** Possible ways to create a lexicon are through:

- Expert annotators.
- Crowdsourcing in a two-step procedure:
  1. Ask questions related to synonyms (e.g., which word is closest in meaning to *startle*?).
  2. Rate the association of words with emotions (e.g., how does *startle* associate with *joy*, *fear*, *anger*, ...?).
- Semi-supervised induction of labels from a small set of annotated data (i.e.,

seed labels). It works by looking for words that appear together with the ones with a known sentiment.

- Supervised learning using annotated data.

### 3.3.2. Properties

Naive Bayes has the following properties:

- It is generally effective with short sequences and fewer data samples.
- It is robust to irrelevant features (i.e., words that appear in both negative and positive sentences) as they cancel out each other.
- It has good performance in domains with many equally important features (contrarily to decision trees).
- The independence assumption might produce overestimated predictions.

**Remark.** Naive Bayes is a good baseline when experimenting with text classifications.

## 3.4. Logistic regression

**Features engineering** Determine features by hand from the data (e.g., number of positive and negative lexicon).

Features engineering

**Binary logistic regression** Discriminative probabilistic model that computes the joint distribution  $\mathcal{P}(c|d)$  of the class  $c$  given the document  $d$ .

Binary logistic regression

Given the input features  $\mathbf{x} = [x_1, \dots, x_n]$ , logistic regression computes the following:

$$\sigma\left(\sum_{i=1}^n w_i x_i + b\right) = \sigma(\mathbf{w}\mathbf{x} + b)$$

where  $\sigma$  is the sigmoid function.

**Loss** The loss function should aim to maximize the probability of predicting the correct label  $\hat{y}$  given the observation  $\mathbf{x}$ . This can be expressed as a Bernoulli distribution:

$$\mathcal{P}(y|x) = \hat{y}^y (1 - \hat{y})^{1-y} = \begin{cases} 1 - \hat{y} & \text{if } y = 0 \\ \hat{y} & \text{if } y = 1 \end{cases}$$

By applying a log-transformation and inverting the sign, this corresponds to the cross-entropy loss in the binary case:

$$\mathcal{L}_{\text{BCE}}(\hat{y}, y) = -\log(\mathcal{P}(y|x)) = -[y \log(\hat{y}) + (1 - y) \log(1 - \hat{y})]$$

**Optimization** As cross-entropy is convex, SGD is well suited to find the parameters  $\boldsymbol{\theta}$  of a logistic regressor  $f$  over batches of  $m$  examples by solving:

$$\arg \min_{\boldsymbol{\theta}} \sum_{i=1}^m \mathcal{L}_{\text{BCE}}(\hat{y}^{(i)}, f(x^{(i)}; \boldsymbol{\theta})) + \alpha \mathcal{R}(\boldsymbol{\theta})$$

where  $\alpha$  is the regularization factor and  $\mathcal{R}(\boldsymbol{\theta})$  is the regularization term. Typical regularization approaches are:

**Lasso regression (L1)**  $\mathcal{R}(\theta) = \|\theta\|_1 = \sum_{j=1}^n |\theta_j|$ .

**Ridge regression (L2)**  $\mathcal{R}(\theta) = \|\theta\|_2^2 = \sum_{j=1}^n \theta_j^2$ .

**Multinomial logistic regression** Extension of logistic regression to the multi-class case. The joint probability becomes  $\mathcal{P}(y = c|x)$  and softmax is used in place of the sigmoid.

Multinomial logistic regression

Cross-entropy is extended over the classes  $C$ :

$$\mathcal{L}_{\text{CE}}(\hat{y}, y) = - \sum_{c \in C} \mathbb{1}\{y = c\} \log(\mathcal{P}(y = c|x))$$

### 3.4.1. Properties

Logistic regression has the following properties:

- It is generally effective with large documents or datasets.
- It is robust to correlated features.

**Remark.** Logistic regression is also a good baseline when experimenting with text classification.

As they are lightweight to train, it is a good idea to test both naive Bayes and logistic regression to determine the best baseline for other experiments.

## 3.5. Metrics

### 3.5.1. Binary classification

**Contingency table**  $2 \times 2$  table matching predictions to ground truths. It contains true positives (TP), false positives (FP), false negatives (FN), and true negatives (TN).

Contingency table

**Recall**  $\frac{\text{TP}}{\text{TP} + \text{FN}}$ .

Recall

**Precision**  $\frac{\text{TP}}{\text{TP} + \text{FP}}$ .

Precision

**Accuracy**  $\frac{\text{TP} + \text{TN}}{\text{TP} + \text{FP} + \text{FN} + \text{TN}}$ .

Accuracy

**Remark.** Accuracy is a reasonable metric only when classes are balanced.

**F1 score**  $\frac{2 \cdot \text{recall} \cdot \text{precision}}{\text{recall} + \text{precision}}$ .

F1 score

### 3.5.2. Multi-class classification

**Confusion matrix**  $c \times c$  table matching predictions to ground truths.

Confusion matrix

**Precision/Recall** Precision and recall can be defined class-wise (i.e., consider a class as the positive label and the others as the negative).

Precision/Recall

**Micro-average precision/recall** Compute the contingency table of each class and collapse them into a single table. Compute precision or recall on the pooled contingency table.

Micro-average precision/recall

**Remark.** This approach is sensitive to the most frequent class.

**Macro-average precision/recall** Compute precision or recall class-wise and then average over the classes.

Macro-average precision/recall

**Remark.** This approach is reasonable if the classes are equally important.

**Remark.** Macro-average is more common in NLP.

**Example.**

		gold labels			
		urgent	normal	spam	
system output	urgent	8	10	1	$\text{precision}_u = \frac{8}{8+10+1}$
	normal	5	60	50	$\text{precision}_n = \frac{5+60+50}{200}$
	spam	3	30	200	$\text{precision}_s = \frac{3+30+200}{3+30+200}$
		$\text{recall}_u = \frac{8}{8+5+3}$	$\text{recall}_n = \frac{60}{10+60+30}$	$\text{recall}_s = \frac{200}{1+50+200}$	

Figure 3.1.: Confusion matrix

Class 1: Urgent		Class 2: Normal		Class 3: Spam		Pooled	
	true	true	true	true	true	true	true
	urgent	normal	spam	spam	yes	no	yes
system	8	60	200	200	268	99	268
urgent	11	55	33	33	99	99	99
system	8	40	51	51	99	635	99
not	340	212	83	83	635	635	635

$\text{precision} = \frac{8}{8+11} = .42$     
  $\text{precision} = \frac{60}{60+55} = .52$     
  $\text{precision} = \frac{200}{200+33} = .86$     
  $\text{microaverage precision} = \frac{268}{268+99} = .73$

$\text{macroaverage precision} = \frac{.42+.52+.86}{3} = .60$

Figure 3.2.: Class-wise contingency tables, pooled contingency table, and micro/macro-average precision

### 3.5.3. Cross-validation

**n-fold cross-validation** Tune a classifier on different sections of the training data:

1. Randomly choose a training and validation set.
2. Train the classifier.
3. Evaluate the classifier on a held-out test set.
4. Repeat for  $n$  times.

*n*-fold cross-validation

### 3.5.4. Statistical significance

**p-value** Measure to determine whether a model  $A$  is outperforming a model  $B$  on a given test set by chance (i.e., test the null hypothesis  $H_0$  or, in other words, test that there is no relation between  $A$  and  $B$ ).

*p*-value

Given:

- A test set  $x$ ,
- A random variable  $X$  over the test sets (i.e., another test set),
- Two models  $A$  and  $B$ , such that  $A$  is better than  $B$  by  $\delta(x)$  on the test set  $x$ ,

the  $p$ -value is defined as:

$$p\text{-value}(x) = \mathcal{P}(\delta(X) > \delta(x) | H_0)$$

There are two cases:

- $p\text{-value}(x)$  is big: the null hypothesis holds (i.e.,  $\mathcal{P}(\delta(X) > \delta(x))$  is high under the assumption that  $A$  and  $B$  are not related), so  $A$  outperforms  $B$  by chance.
- $p\text{-value}(x)$  is small (i.e.,  $< 0.05$  or  $< 0.01$ ): the null hypothesis is rejected, so  $A$  actually outperforms  $B$ .

**Bootstrapping test** Approach to compute  $p$ -values.

Bootstrapping test

Given a test set  $x$ , multiple virtual test sets  $\bar{x}^{(i)}$  are created by sampling with replacement (it is assumed that the new sets are representative). The performance difference  $\delta(\cdot)$  is computed between two models and the  $p$ -value is determined as the frequency of:

$$\delta(\bar{x}^{(i)}) > 2\delta(x)$$

| **Remark.**  $\delta(x)$  is doubled due to theoretical reasons.

**Example.** Consider two models  $A$  and  $B$ , and a test set  $x$  with 10 samples. From  $x$ , multiple new sets (in this case of the same size) can be sampled. In the following table, each cell indicates which model correctly predicted the class:

	1	2	3	4	5	6	7	8	9	10	A%	B%	$\delta(\cdot)$
$x$	AB	A	AB	B	A	B	A	AB	-	A	0.7	0.5	0.2
$\bar{x}^{(1)}$	A	AB	A	B	B	A	B	AB	-	AB	0.6	0.6	0.0
$\vdots$	$\vdots$	$\vdots$	$\vdots$	$\vdots$	$\vdots$	$\vdots$	$\vdots$	$\vdots$	$\vdots$	$\vdots$	$\vdots$	$\vdots$	$\vdots$

A possible way to sample  $\bar{x}^{(1)}$  is (w.r.t. the indexes of the examples in  $x$ ) [2, 3, 3, 2, 4, 6, 2, 4, 1, 9, 1].

### 3.6. Affective meaning

The affective meaning of a text corpus can vary depending on:

**Personality traits** Stable behavior and personality of a person (e.g., nervous, anxious, reckless, ...).

**Attitude** Enduring sentiment towards objects or people (e.g., liking, loving, hating, ...).

**Interpersonal stance** Affective stance taken in a specific interaction (e.g., distant, cold, warm, ...).

**Mood** Affective state of low intensity and long duration often without an apparent cause (e.g., cheerful, gloomy, irritable, ...).

**Emotion** Brief response to an external or internal event of major significance (e.g., angry, sad, joyful, ...).

| **Remark.** Emotion is the most common subject in affective computing.

### 3.6.1. Emotion

**Theory of emotion** There are two main theories of emotion:

**Basic emotions** Discrete and fixed range of atomic emotions.

Basic emotions

| **Remark.** Emotions associated to a word might be in contrast. For instance, in the NRC Word-Emotion Association Lexicon the word **thirst** is associated to both *anticipation* and *surprise*.

**Continuum emotions** Describe emotions in a 2 or 3 dimensional space with the following features:

Continuum emotions

**Valence** Pleasantness of a stimulus.

**Arousal** Intensity of emotion.

**Dominance** Degree of control on the stimulus.

| **Remark.** Valence is often used as a measure of sentiment.

## 4. Semantics embedding

### 4.1. Traditional semantic representation

**Lemma/citation form** Syntactic form of a word.

Lemma

| **Example.** The word **pipe**.

**Word sense** Meaning component of a word.

Word sense

**Polysemous lemma** Lemma with multiple senses.

| **Example.** Possible senses of the word **pipe** are: the music instrument, the conduit to transport material, . . . .

**Supersense** Semantic category for senses.

Supersense

**Word sense disambiguation (WSD)** Task of determining the correct sense of a word.

Word sense disambiguation (WSD)

#### 4.1.1. Sense relations

**Synonym** Relation of (near) identity between two senses of two different words (i.e., same propositional meaning).

Synonym

| **Remark** (Principle of contrast). A different linguistic form is probably due to some, maybe subtle, difference in meaning.

**Antonym** Relation of opposition, with respect to one feature of meaning, between two senses. More specifically, antonyms can be:

Antonym

- An opposition between two ends of a scale (e.g., **long/short**).
- A reversive (e.g., **up/down**).

**Subordination** Specificity (i.e., is-a) relation between two senses.

Subordination

| **Example.** **car** is a subordinate of **vehicle**.

**Superordination** Generalization relation between two senses.

Superordination

| **Example.** **furniture** is a superordinate of **lamp**.

**Meronym** Part-of relation between two senses.

Meronym

| **Remark.** Relations among word senses can be seen as a graph.

#### 4.1.2. Common ontologies

**WordNet** Database of semantic relations of English words.

WordNet

**BabelNet** Multilingual database of semantic relations.

BabelNet

#### 4.1.3. Word relations

**Word similarity** Measure the meaning similarity of words (i.e., relation between words and not senses).

Word similarity



| **Remark.** Working with words is easier than senses.

| **Example.** Cat and dog are not synonyms but have similar meaning (i.e., pets).

**Word relatedness** Measure the context relation of words. Word relatedness

| **Example.** car/bike are similar while car/fuel are related but not similar.

**Semantic field** Words that cover a particular domain and have structured relations with each other. Semantic field

| **Example.** In the context of a hospital, surgeon, scalpel, nurse, anesthetic, and hospital belong to the same semantic field.

**Topic model** Unsupervised method to cluster the topics in a document based on how a word is used in its context. Topic model

**Semantic frames** Words that describe the perspective or participants of a particular event. Semantic frames

| **Example.** In a commercial transaction, a buyer trades money with a seller in return of some good or service.

**Semantic role labeling (SRL)** Task of determining the frames and their semantic role. Semantic role labeling (SRL)

## 4.2. Vector semantics

**Connotation** Affective meaning of a word. Connotation

| **Remark.** As described in Section 3.6, emotions can be represented in a vector space. Therefore, word meanings can also be represented as vectors.

**Vector semantics intuitions** Vector semantics lay on two intuitions:

**Distributionalism intuition** The meaning of a word is defined by its environment or distribution (i.e., neighboring words). Words with a similar distribution are likely to have the same meaning. Distributionalism intuition

**Vector intuition** Define the meaning of a word as a point in an  $N$ -dimensional space. Vector intuition

**Embedding** Vector representation of a word where words with a similar meaning are nearby in the vector space. Embedding

Two common embedding models are:

**TF-IDF** Sparse embedding based on the counts of nearby words. TF-IDF

**Word2vec** Dense embedding learned by training a classifier to distinguish nearby and far-away words. Word2vec

### 4.2.1. Sparse embeddings

**Co-occurrence matrix** Matrix representing the frequency that words occur with the others. Co-occurrence matrix

Different design choices can be considered:

- Matrix design.
- Reweighting.

- Dimensionality reduction.
- Vector comparison metric.

**Matrix design** Shape and content of the co-occurrence matrix.

**Term-document matrix** Given a vocabulary  $V$  and a set of documents  $D$ , a term-document matrix has shape  $|V| \times |D|$  and counts the occurrences of each word in each document.

Term-document matrix

**Remark.** This representation allows to encode both documents (i.e., by considering the matrix column-wise) and words (i.e., by considering the matrix row-wise).

**Example.** An excerpt of a possible term-document matrix for Shakespeare is:

	<i>As You Like It</i>	<i>Twelfth Night</i>	<i>Julius Caesar</i>	<i>Henry V</i>
<b>battle</b>	1	0	7	13
<b>good</b>	114	80	62	89
<b>fool</b>	36	58	1	4
<b>wit</b>	20	15	2	3

The representation for the document *As You Like It* is  $[1, 114, 36, 20]$ , while the representation of the word **battle** is  $[1, 0, 7, 13]$ .

**Word-word matrix** Given a vocabulary  $V$ , a word-word matrix has shape  $|V| \times |V|$ . Rows represent target words and columns are context words. Given a training corpus, the word at each row is represented by counting its co-occurrences with the others within a context of  $N$  words.

Word-word matrix

**Remark.** A larger context window captures more semantic information. A smaller window captures more syntactic information.

**Example.** A possible word-word matrix is:

	aardvark	...	computer	data	result	pie	sugar	...
<b>cherry</b>	0	...	2	8	9	442	25	...
<b>strawberry</b>	0	...	0	0	1	60	19	...
<b>digital</b>	0	...	1670	1683	85	5	4	...
<b>information</b>	0	...	3325	3982	378	5	13	...

**Reweighting** Rescale the vectors to emphasize important features and down-weight irrelevant words.

**Remark** (Frequency paradox). Raw frequencies are not an ideal representation for words as they are skewed and not discriminative. Moreover, overly frequent words (e.g., stop words) do not provide context information.

**Term frequency-inverse document frequency (TF-IDF)** Based on term-document occurrences. Given a word  $t$  and a document  $d$ , it is computed as:

Term frequency-inverse document frequency (TF-IDF)

$$\text{tf-idf}(t, d) = \text{tf}(t, d) \cdot \text{idf}(t)$$

where:

**Term frequency (tf)** Log-transformed frequency count of a word  $t$  in a document  $d$ :

$$\text{tf}(t, d) = \begin{cases} 1 + \log_{10}(\text{count}(t, d)) & \text{if } \text{count}(t, d) > 0 \\ 0 & \text{otherwise} \end{cases}$$

**Inverse document frequency (idf)** Inverse occurrence count of a word  $t$  across all documents:

$$\text{idf}(t) = \log_{10} \left( \frac{\text{count}(t)}{\text{df}_t} \right)$$

where  $\text{df}_t$  is the number of documents in which the term  $t$  occurs.

**Remark.** Words that occur in a few documents have a high **idf**. Therefore, stop words, which appear often, have a low **idf** and are down-weighted.

**Example.** Consider the term-document matrix with **tf** in parentheses:

	<i>As You Like It</i>	<i>Twelfth Night</i>	<i>Julius Caesar</i>	<i>Henry V</i>
<b>battle</b>	1 (1)	0 (0)	7 (1.845)	13 (2.114)
<b>good</b>	114 (3.057)	80 (2.903)	62 (2.792)	89 (2.949)
<b>fool</b>	36 (2.553)	58 (2.763)	1 (1)	4 (1.602)
<b>wit</b>	20 (2.301)	15 (2.176)	2 (1.301)	3 (1.477)

Assume that the **df** and **idf** of the words are:

Word	df	idf
<b>battle</b>	21	0.246
<b>good</b>	37	0
<b>fool</b>	36	0.012
<b>wit</b>	34	0.037

The resulting TF-IDF weighted matrix is:

	<i>As You Like It</i>	<i>Twelfth Night</i>	<i>Julius Caesar</i>	<i>Henry V</i>
<b>battle</b>	0.246	0	0.454	0.520
<b>good</b>	0	0	0	0
<b>fool</b>	0.030	0.033	0.001	0.002
<b>wit</b>	0.085	0.081	0.048	0.054

**Positive point-wise mutual information (PPMI)** Based on term-term occurrences. Given a word  $w$  and a context word  $c$ , it determines whether they are correlated or occur by chance as follows:

$$\text{PPMI}(w, c) = \max \{ \text{PMI}(w, c), 0 \}$$

where:

**Point-wise mutual information (PMI)**

$$\text{PMI}(w, c) = \log_2 \left( \frac{\mathcal{P}(w, c)}{\mathcal{P}(w)\mathcal{P}(c)} \right) \in (-\infty, +\infty)$$

where:

Positive point-wise mutual information (PPMI)

- The numerator is the probability that  $w$  and  $c$  co-occur by correlation.
- The denominator is the probability that  $w$  and  $c$  co-occur by chance.

**Remark.** PMI  $> 1$  indicates correlated co-occurrence. Otherwise, it is by chance.

**Remark (Weighting PPMI).** PMI is biased towards infrequent events and returns very high values for them. This can be solved by either:

- Using add- $k$  smoothing (typically,  $k \in [0.1, 3]$ ).
- Slightly increasing the probability of rare context words such that  $\mathcal{P}_\alpha(c) = \frac{\text{count}(c)^\alpha}{\sum_{c'} \text{count}(c')^\alpha}$  (typically,  $\alpha = 0.75$ ).

**Example.** Consider the term-term matrix:

	computer	data	result	pie	sugar	count( $w$ )
cherry	2	8	9	442	25	486
strawberry	0	0	1	60	19	80
digital	1670	1683	85	5	4	3447
information	3325	3982	378	5	13	7703
count( $c$ )	4977	5673	473	512	61	11716

The PPMI between **information** and **data** can be computed as:

$$\begin{aligned} \mathcal{P}(\text{information, data}) &= \frac{3982}{11716} = 0.3399 \\ \mathcal{P}(\text{information}) &= \frac{7703}{11716} = 0.6575 \\ \mathcal{P}(\text{data}) &= \frac{5673}{11716} = 0.4872 \\ \text{PPMI}(\text{information, data}) &= \max \left\{ \log_2 \left( \frac{0.3399}{0.6575 \cdot 0.4872} \right), 0 \right\} = 0.0944 \end{aligned}$$

**Remark.** Reweighting loses information about the magnitude of the counts.

**Dimensionality reduction** Reduce the dimensionality of the embeddings.

**Vector comparison** Metric to determine the distance of two embeddings.

**Dot product**  $\mathbf{w} \cdot \mathbf{v} = \sum_{i=1}^n w_i v_i$ .

**Length** Compare the length  $|\mathbf{v}| = \sqrt{\sum_{i=1}^n v_i^2}$  of the vectors.

**Cosine similarity**  $\frac{\mathbf{w} \cdot \mathbf{v}}{|\mathbf{w}| |\mathbf{v}|}$ .

#### 4.2.2. Dense non-contextual embeddings

**Remark.** Dense embeddings are usually:

- Easier to process with machine learning algorithms.
- Able to generalize better than simply counting.
- Handle synonyms better.

**Neural language modeling** Use a neural network to predict the next word  $w_{n+1}$  given an input sequence  $w_{1..n}$ . The general flow is the following:

1. Encode the input words into one-hot vectors ( $\mathbb{N}^{|V| \times n}$ ).
2. Project the input vectors with an embedding matrix  $E \in \mathbb{R}^{d \times |V|}$  that encodes them into  $d$ -dimensional vectors.
3. Pass the embedding into the hidden layers.
4. The final layer is a probability distribution over the vocabulary ( $\mathbb{R}^{|V| \times 1}$ ).

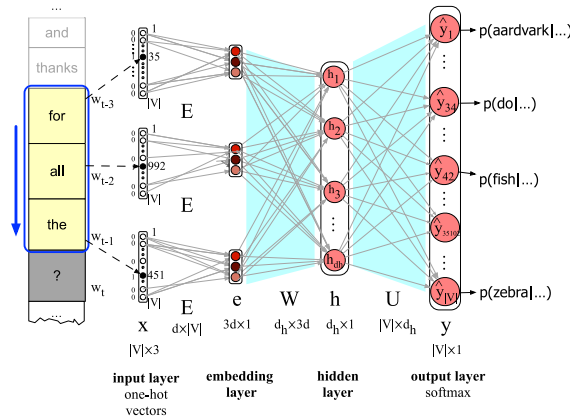

Figure 4.1.: Example of neural language model with a context of 3 tokens

**Remark.** The embedding matrix  $E$  can be used independently to embed words. In fact, by construction, the  $i$ -th column of  $E$  represents the embedding of the  $i$ -th token of the vocabulary.

**Training** Given a text corpus, training is done sequentially in a self-supervised manner by sliding a context window over the sequence. At each iteration, the next word is predicted and cross-entropy is used as loss.

**Remark.** The initial embedding matrix is usually initialized using statistical methods and not randomly.

**Word2vec** Word embedding framework that encodes a target word based on the context words near it.

Two training variants are available in Word2vec:

**Continuous bag-of-words (CBOW)** Given the context words, predict the target word.

**Skip-gram** Given the target word, predict the (position independent) context words.

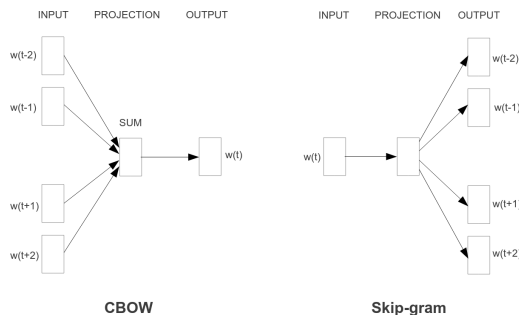

**Skip-gram model** Given a context word  $c$  and a target word  $w$ , a classifier is trained to determine whether  $c$  appears in the context of  $w$ . After training, the weights of the classifier are used as the skip-gram model to embed words.

Skip-gram model

**Remark.** In practice, for an easier optimization, the skip-gram model learns two sets of embeddings  $\mathbf{W} \in \mathbb{R}^{|V| \times d}$  and  $\mathbf{C} \in \mathbb{R}^{|V| \times d}$  for the target and context words, respectively. Therefore, it has two sets of parameters  $\theta = \langle \mathbf{W}, \mathbf{C} \rangle$ . At the end, they can either be averaged, concatenated, or one can be dropped.

**Training (softmax)** Given the target word  $w$  and context word  $c$ , and their embeddings  $\mathbf{w}$  and  $\mathbf{c}$ , the skip-gram model computes their similarity as the dot product. The probability that  $c$  is in the context of  $w$  is then computed through a softmax as:

$$\mathcal{P}(c|w; \theta) = \frac{\exp(\mathbf{c} \cdot \mathbf{w})}{\sum_{v \in V} \exp(\mathbf{v} \cdot \mathbf{w})}$$

Given a training sequence  $w_1, \dots, w_T$  and a context window of size  $m$ , training is done by iterating over each possible target word  $w_t$  and considering the conditional probabilities of its neighbors. Then, the loss is defined as the average negative log-likelihood defined as follows:

$$\mathcal{L}(\theta) = -\frac{1}{T} \sum_{t=1}^T \sum_{\substack{-m \leq j \leq m \\ j \neq 0}} \log(\mathcal{P}(w_{t+j}|w_t; \theta))$$

**Remark.** Due to the normalization factor over the whole vocabulary, using softmax for training is expensive.

**Training (negative sampling)** Use a binary logistic regressor as classifier. The two classes are:

Skip-gram with negative sampling (SGNS)

- Context words within the context window (positive label).
- Randomly sampled words (negative label).

The probabilities can be computed as:

$$\mathcal{P}(+|w, c; \theta) = \sigma(\mathbf{c} \cdot \mathbf{w}) \quad \mathcal{P}(-|w, c; \theta) = 1 - \mathcal{P}(+|w, c; \theta)$$

It is assumed context-independent words, therefore, if the context is a sequence, the probability is computed as follows:

$$\mathcal{P}(+|w, c_{1..L}; \theta) = \prod_{i=1}^L \sigma(\mathbf{c}_i \cdot \mathbf{w})$$

At each iteration, the batch is composed of a single positive examples and  $K$  negative examples randomly sampled according to their weighted unigram probability  $\mathcal{P}_\alpha(w) = \frac{\text{count}(w)^\alpha}{\sum_{v \in V} \text{count}(v)^\alpha}$  ( $\alpha$  is used to give rarer words a slightly higher probability).

Given a batch, the loss is defined as:

$$\begin{aligned} \mathcal{L}(\theta) &= -\log \left( \mathcal{P}(+|w, c^{\text{pos}}; \theta) \prod_{i=1}^K \mathcal{P}(-|w, c_i^{\text{neg}}; \theta) \right) \\ &= -\left( \log(\sigma(\mathbf{c}^{\text{pos}} \cdot \mathbf{w})) + \sum_{i=1}^K \log(\sigma(-\mathbf{c}_i^{\text{neg}} \cdot \mathbf{w})) \right) \end{aligned}$$

**fastText** Extension of Word2vec based on subwords to deal with out-of-vocabulary words. fastText

A word is represented both as itself and a bag of  $n$ -grams. Both whole words and  $n$ -grams have an embedding. The overall embedding of a word is represented through the sum of its constituent  $n$ -grams.

**Example.** With  $n = 3$ , the word **where** is represented both as  $\langle \text{where} \rangle$  and  $\langle \text{wh, whe, her, ere, re} \rangle$  ( $\langle$  and  $\rangle$  are boundary characters).

**GloVe** Based on the term-term co-occurrence (within a window) probability matrix that indicates for each word its probability of co-occurring with the other words. GloVe

The objective is to learn two sets of embeddings  $\theta = \langle \mathbf{W}, \mathbf{C} \rangle$  such that their similarity is close to their log-probability of co-occurring. Given the term-term matrix  $\mathbf{X}$ , the loss for a target word  $w$  and a context word  $c$  is defined as:

$$\mathcal{L}(\theta) = (\mathbf{c} \cdot \mathbf{w} - \log(\mathbf{X}[c, w]))^2$$

**Remark.** Empirically, for GloVe it has been observed that the final embedding matrix obtained as  $\mathbf{W} + \mathbf{C}$  works better.

**Example.** A possible term-term co-occurrence probability for the words **ice** and **steam** is the following:

	$k = \text{solid}$	$k = \text{gas}$	$k = \text{water}$	$k = \text{fashion}$
$\mathcal{P}(k \text{ice})$	$1.9 \times 10^{-4}$	$6.6 \times 10^{-5}$	$3.0 \times 10^{-3}$	$1.7 \times 10^{-5}$
$\mathcal{P}(k \text{steam})$	$2.2 \times 10^{-5}$	$7.8 \times 10^{-4}$	$2.2 \times 10^{-3}$	$1.8 \times 10^{-5}$

**ice** is more likely to co-occur with **solid** while **steam** is more likely to co-occur with **gas**. GloVe uses this information when determining the embeddings.

### 4.3. Embeddings properties

#### 4.3.1. Embeddings similarity

**Context size** The window size used to collect counts or determine context words can result in different embeddings. Context size

As a general rule, smaller windows tend to capture more syntactic features while a larger window encodes more topically related but not necessarily similar words.

**Similarity orders** Two words have: Similarity orders

**First-order co-occurrence** If they are nearby each other.

**Second-order co-occurrence** If they have similar context words.

**Relational similarity** Dense embeddings are able to capture relational meanings. Relational similarity

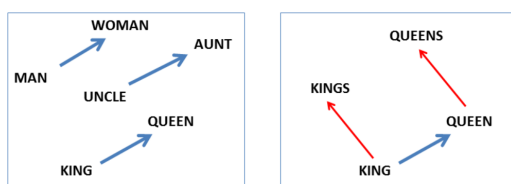

**Parallelogram model** Given the problem “ $a$  is to  $b$  as  $a^*$  is to  $b^*$ ” ( $a : b :: a^* : b^*$ ), the parallelogram model solves it as:

$$b^* = \arg \min_x \text{distance}(x, b - a + a^*)$$

**Example.** In Word2vec, the following operation between embeddings can be done:

$$\text{Paris} - \text{France} + \text{Italy} \approx \text{Rome}$$

**Remark.** Even if it sometimes works, parallelogram model is not guaranteed to always produce the expected result.

### 4.3.2. Embeddings analysis

**Word history** Trained on different corpora, dense embeddings can provide a semantic evolution of words by analyzing its neighboring embeddings. Word history

**Example.**

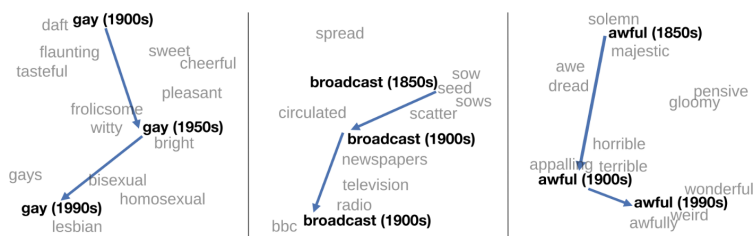

Figure 4.2.: Neighboring embeddings of the same words encoded using Word2vec trained on different corpora from different decades

**Example.**

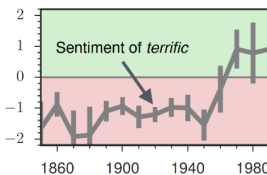

Figure 4.3.: Sentiment for the word **terrific** analyzed using the embeddings obtained by training on different corpora

**Cultural bias** Embeddings reflect implicit biases in the training corpus. Cultural bias

**Implicit association test** Determine how associated are concepts and attributes.

**Example.** Using the parallelogram model to solve:

$$\text{father} : \text{doctor} :: \text{mother} : x$$

The closest words for  $x$  are **homemaker**, **nurse**, **receptionist**, ...

**Example.** African-American and Chinese names are closer to unpleasant words compared to European-American names.

**Example.** Using the Google News dataset as training corpus, there is a correlation between the women bias in job words embeddings and the percentage of women over men in those jobs.



Woman bias for a word  $w$  is computed as:

$$d_{\text{women}}(w) - d_{\text{men}}(w)$$

where  $d_{\text{women}}(w)$  is the average embedding distance between words representing women (e.g., **she**, **female**, ...) and the word  $w$ . The same idea is applied to  $d_{\text{men}}(w)$ .

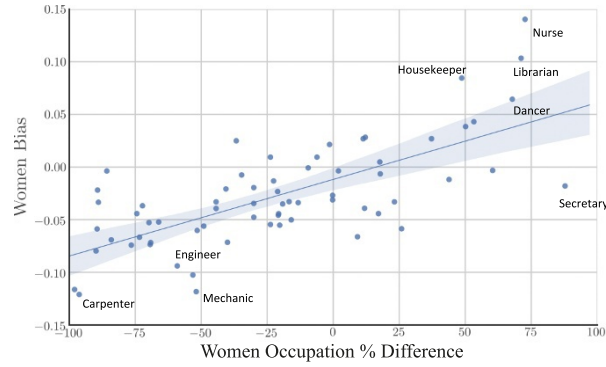

Figure 4.4.: Relationship between the relative percentage of women in an occupation and the women bias.

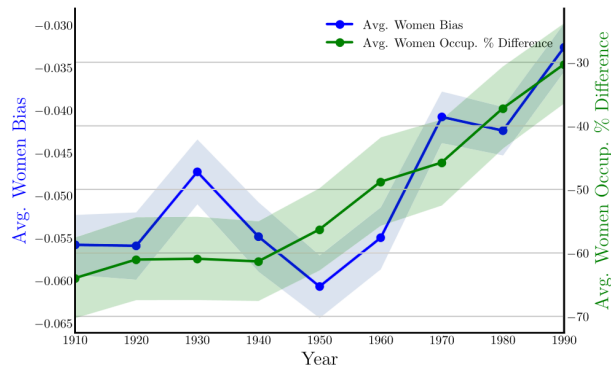

Figure 4.5.: Average women bias vs average women occupation difference over time.

# 5. Recurrent neural networks

## 5.1. Architectures

### 5.1.1. (Elman) recurrent neural network

**Recurrent neural network (RNN)** Neural network that processes a sequential input. At each iteration, an input is fed to the network and the hidden activation is computed considering both the input and the hidden activation of the last iteration.

Recurrent neural network (RNN)

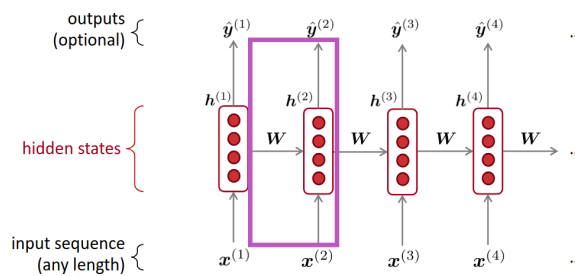

Figure 5.1.: RNN unrolled in time

**RNN language model (RNN-LM)** Given an input word  $w^{(t)}$ , an RNN-LM does the following:

RNN language model (RNN-LM)

1. Compute the embedding  $\mathbf{e}^{(t)}$  of  $w^{(t)}$ .
2. Compute the hidden state  $\mathbf{h}^{(t)}$  considering the hidden state  $\mathbf{h}^{(t-1)}$  of the previous step:

$$\mathbf{h}^{(t)} = f(\mathbf{W}_e \mathbf{e}^{(t)} + \mathbf{W}_h \mathbf{h}^{(t-1)} + \mathbf{b}_1)$$

3. Compute the output vocabulary distribution  $\hat{\mathbf{y}}^{(t)}$ :

$$\hat{\mathbf{y}}^{(t)} = \text{softmax}(\mathbf{U} \mathbf{h}^{(t)} + \mathbf{b}_2)$$

4. Repeat for the next token.

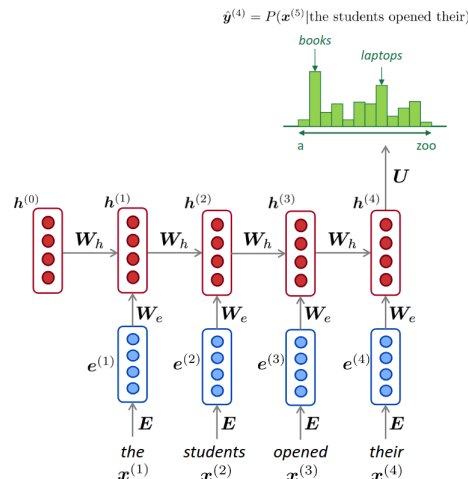

| **Remark.** RNN-LMs allow to generate the output autoregressively.

**Training** Given the predicted distribution  $\hat{\mathbf{y}}^{(t)}$  and ground-truth  $\mathbf{y}^{(t)}$  at step  $t$ , the loss is computed as the cross-entropy:

$$\mathcal{L}^{(t)}(\boldsymbol{\theta}) = - \sum_{v \in V} \mathbf{y}_v^{(t)} \log \left( \hat{\mathbf{y}}_v^{(t)} \right)$$

**Teacher forcing** During training, as the ground-truth is known, the input at each step is the correct token even if the previous step outputted the wrong value.

Teacher forcing

| **Remark.** This allows to stay closer to the ground-truth and avoid completely wrong training steps.

| **Remark.** RNNs grow in width and not depth, and cannot be parallelized.

### 5.1.2. Long short-term memory

| **Remark** (Vanishing gradient). In RNNs, the gradient of distant tokens vanishes through time. Therefore, long-term effects are hard to model.

**Long short-term memory (LSTM)** Architecture where at each step  $t$  outputs:

Long short-term memory (LSTM)

**Hidden state**  $\mathbf{h}^{(t)} \in \mathbb{R}^n$  as in RNNs.

**Cell state**  $\mathbf{c}^{(t)} \in \mathbb{R}^n$  with the responsibility of long-term memory.

**Gates** Non-linear operators to manipulate the cell state (in the following part,  $\mathbf{W}_*$ ,  $\mathbf{U}_*$ , and  $\mathbf{b}_*$  are parameters).

**Forget gate** Controls what part of the cell state to keep:

Forget gate

$$\mathbf{f}^{(t)} = \sigma \left( \mathbf{W}_f \mathbf{h}^{(t-1)} + \mathbf{U}_f \mathbf{x}^{(t)} + \mathbf{b}_f \right)$$

**Input gate** Controls what part of the input to write in the cell state:

Input gate

$$\mathbf{i}^{(t)} = \sigma \left( \mathbf{W}_i \mathbf{h}^{(t-1)} + \mathbf{U}_i \mathbf{x}^{(t)} + \mathbf{b}_i \right)$$

**Output gate** Controls what part of the cell state to include in the output hidden state:

Output gate

$$\mathbf{o}^{(t)} = \sigma \left( \mathbf{W}_o \mathbf{h}^{(t-1)} + \mathbf{U}_o \mathbf{x}^{(t)} + \mathbf{b}_o \right)$$

Updates are done as follows:

**New cell state content**  $\tilde{\mathbf{c}}^{(t)} = \tanh \left( \mathbf{W}_c \mathbf{h}^{(t-1)} + \mathbf{U}_c \mathbf{x}^{(t)} + \mathbf{b}_c \right)$ .

**Cell state**  $\mathbf{c}^{(t)} = \mathbf{f}^{(t)} \cdot \mathbf{c}^{(t-1)} + \mathbf{i}^{(t)} \cdot \tilde{\mathbf{c}}^{(t)}$ .

**Hidden state**  $\mathbf{h}^{(t)} = \mathbf{o}^{(t)} \cdot \tanh(\mathbf{c}^{(t)})$ .

| **Remark.** LSTMs make it easier to preserve information over time, but they might still be affected by the vanishing gradient problem.

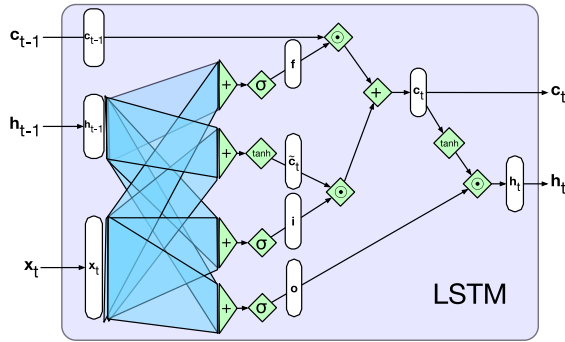

### 5.1.3. Gated recurrent units

**Gated recurrent units (GRU)** Simpler architecture than LSTMs with fewer gates and without the cell state. Gated recurrent units (GRU)

#### Gates

**Update gate** Controls what part of the current hidden state to keep: Update gate

$$\mathbf{u}^{(t)} = \sigma \left( \mathbf{W}_u \mathbf{h}^{(t-1)} + \mathbf{U}_u \mathbf{x}^{(t)} + \mathbf{b}_u \right)$$

**Reset gate** Controls what part of the previous hidden state to use: Reset gate

$$\mathbf{r}^{(t)} = \sigma \left( \mathbf{W}_r \mathbf{h}^{(t-1)} + \mathbf{U}_r \mathbf{x}^{(t)} + \mathbf{b}_r \right)$$

Updates are done as follows:

**New hidden state content**  $\tilde{\mathbf{h}}^{(t)} = \tanh \left( \mathbf{W}_h (\mathbf{r}^{(t)} \cdot \mathbf{h}^{(t-1)}) + \mathbf{U}_h \mathbf{x}^{(t)} + \mathbf{b}_h \right).$

**Hidden state**  $\mathbf{h}^{(t)} = (1 - \mathbf{u}^{(t)}) \cdot \mathbf{h}^{(t-1)} + \mathbf{u}^{(t)} \cdot \tilde{\mathbf{h}}^{(t)}.$

**Remark.** Being faster to train than LSTMs, GRUs are usually a good starting point.

### 5.1.4. Bidirectional RNN

**Bidirectional RNN** Two independent RNNs (of any architecture) that processes the input left-to-right (forward) and right-to-left (backward), respectively. Usually, the output hidden state of a token  $t$  is obtained as the concatenation of the hidden states  $\mathbf{h}_{\text{forward}}^{(t)}$  and  $\mathbf{h}_{\text{backward}}^{(t)}$  of both networks. Bidirectional RNN

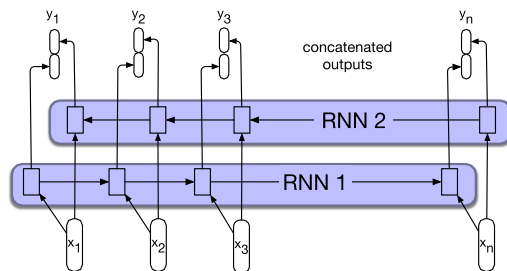

**Remark.** This architecture is not for language modelling (i.e., autoregressive models) as it is assumed that the whole input sequence is available at once.

**Example** (Sequence classification). For sequence classification, the last hidden state of the forward and backward contexts can be used as the representation of the whole sequence to pass to the classifier.

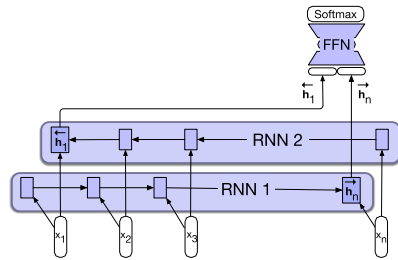

### 5.1.5. Stacked multi-layer RNN

**Stacked RNN** Stack of RNNs (of any architecture) where:

Stacked RNN

- The RNN at the first layer  $l = 1$  processes the input tokens.
- The input of any following layer  $l \geq 2$  is the hidden state  $\mathbf{h}_{l-1}^{(t)}$  of the previous layer.

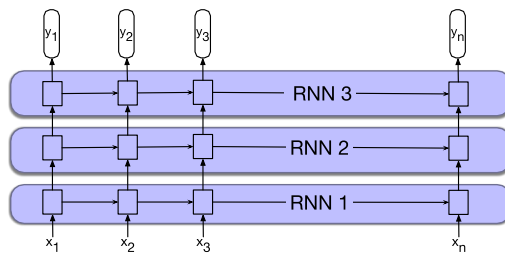

**Remark.** Skip connections between different layers can help to stabilize the gradient.

## 5.2. Applications

**Autoregressive generation** Repeatedly sample a token and feed it back to the network.

Autoregressive generation  
Decoding strategy

**Decoding strategy** Method to select the output token from the output distribution. Possible approaches are:

**Greedy** Select the token with the highest probability.

**Sampling** Randomly sample the token following the probabilities of the output distribution.

**Conditioned generation** Provide an initial hidden state to the RNN (e.g., speech-to-text).

Conditioned generation

**Sequence labeling** Assign a class to each input token (e.g., POS-tagging, named-entity recognition, structure prediction, ...).

Sequence labeling

**Sequence classification** Assign a class to the whole input sequence (e.g., sentiment analysis, document-topic classification, ...).

Sequence classification

**Sentence encoding** Produce a vector representation for the whole input sequence. Possible approaches are:

Sentence encoding

- Use the final hidden state of the RNN.

- Aggregate all the hidden states (e.g., mean).

**Example** (Question answering). The RNN encoder embeds the question that is used alongside the context (i.e., source from which the answer has to be extracted) to solve a labeling task (i.e., classify each token of the context as non-relevant or relevant).

# 6. Attention-based architectures

**Sequence-to-sequence (seq2seq) model** Encoder-decoder architecture where:

**Encoder** Processes the whole input sequence and outputs a representation of it.

**Decoder** Processes the output of the encoder and produces the output sequence.

**Remark.** Training is usually done using teacher forcing and averaging the loss of each output distribution.

Sequence-to-sequence (seq2seq) model

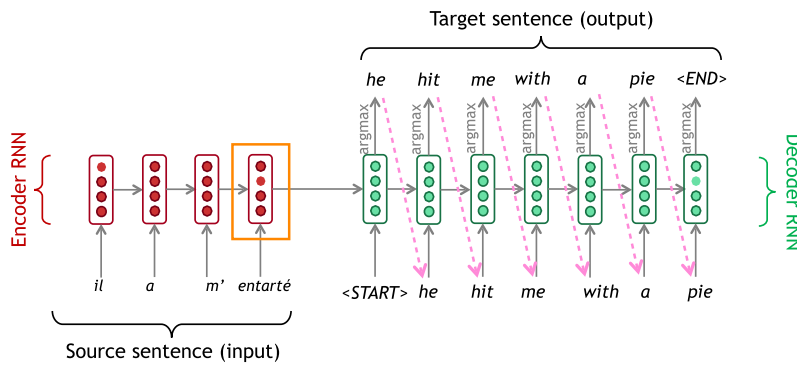

Figure 6.1.: Example of seq2seq network with RNNs

## 6.1. Encoder-decoder RNN with attention

**Seq2seq RNN with attention** Architecture where the decoder can interact with each token processed by the encoder to determine dot-product attention scores (i.e., based on vector similarity).

Seq2seq RNN with attention

The overall flow is the following:

1. The encoder computes its hidden states  $\mathbf{h}^{(1)}, \dots, \mathbf{h}^{(N)} \in \mathbb{R}^h$ .
2. The decoder processes the input tokens one at the time beginning with a <start> token. Its hidden state is initialized with  $\mathbf{h}^{(N)}$ . Consider the token at position  $t$ , the output is determined as follows:
  - a) The decoder outputs the hidden state  $\mathbf{s}^{(t)}$ .
  - b) Attention scores  $\mathbf{e}^{(t)}$  are determined as the dot product between  $\mathbf{s}^{(t)}$  and  $\mathbf{h}^{(i)}$ :

$$\mathbf{e}^{(t)} = [\mathbf{s}^{(t)} \cdot \mathbf{h}^{(1)} \quad \dots \quad \mathbf{s}^{(t)} \cdot \mathbf{h}^{(N)}] \in \mathbb{R}^N$$

$\mathbf{e}^{(t)}$  is used to determine the attention distribution  $\boldsymbol{\alpha}^{(t)}$  that is required to obtain the attention output  $\mathbf{a}^{(t)}$  as the weighted sum of the encoder hidden states:

$$\mathbb{R}^N \ni \boldsymbol{\alpha}^{(t)} = \text{softmax}(\mathbf{e}^{(t)})$$

$$\mathbb{R}^h \ni \mathbf{a}^t = \sum_{i=1}^N \alpha_i^{(t)} \mathbf{h}^{(i)}$$

- c) The overall representation of the  $t$ -th token is the concatenation of the attention and decoder output:

$$[\mathbf{a}^{(t)} \mid \mathbf{s}^{(t)}] \in \mathbb{R}^{2h}$$

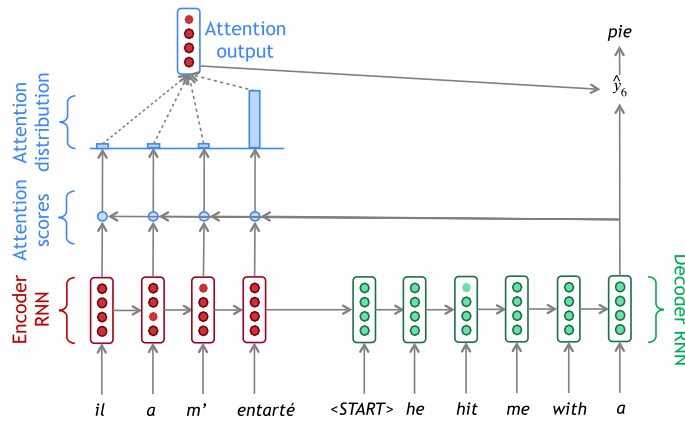

## 6.2. Convolutional neural networks for NLP

**1D convolution (NLP)** Apply a kernel on a sequence of tokens within a window. A kernel of size  $k$  with  $d$ -dimensional token embeddings is represented by a  $k \times d$  weight matrix.

1D convolution

**Remark.** As in computer vision, multiple kernels can be stacked to increase the depth of the representation. Padding, stride, and dilation can also be used to change the receptive field. Pooling is also performed before passing to fully-connected layers.

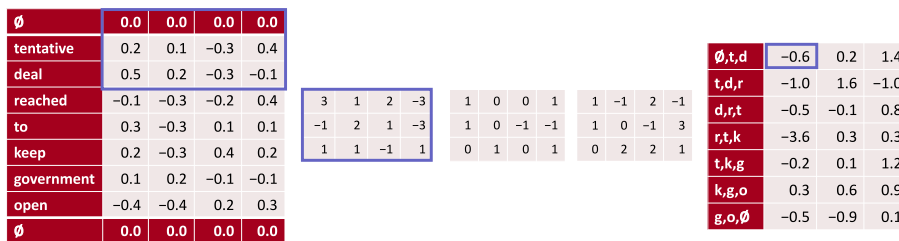

Figure 6.2.: Example of three 1D convolutions with padding 1

**Remark.** Convolutions are easy to parallelize.

**Example** (CNN for sentence classification). A possible multichannel CNN architecture for sentence classification works as follows:

- The input sequence is encoded by stacking both static and learned embeddings (of the same dimensionality).
- Convolutions are applied to each channel. They can work with different widths.
- Pooling is used to flatten the activations and avoid shape mismatch before passing through fully-connected layers.



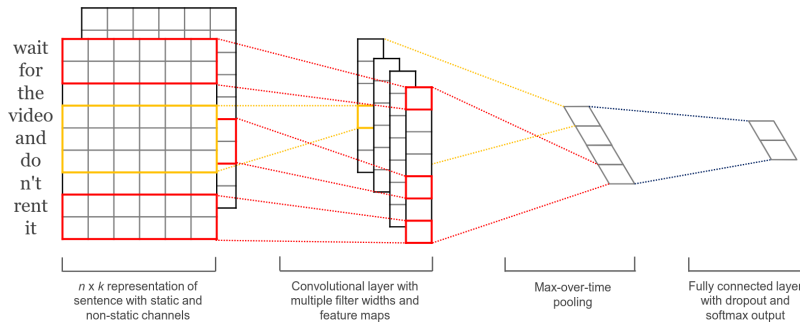

**Example (Character-aware neural LM).**

RNN-LM that works on the character level:

- Given a token, each character is embedded and concatenated.
- Convolutions are used to refine the representation.
- Pooling is used before passing the representation to the RNN.

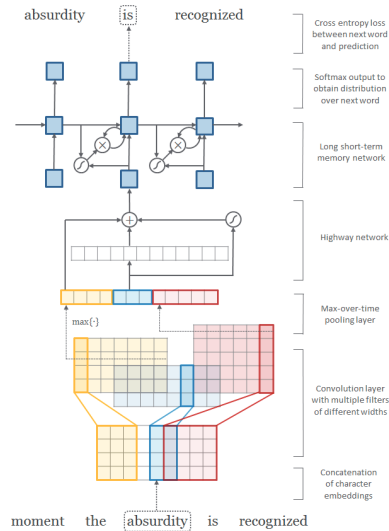

### 6.3. Transformer decoder (for language modelling)

#### 6.3.1. Self-attention

**Self-attention** Component that allows to compute the representation of a token considering the other ones in the input sequence.

Self-attention

Given an input embedding  $\mathbf{x}_i \in \mathbb{R}^{1 \times d_{\text{model}}}$ , self-attention relies on the following values:

**Queries** Used as the reference point for attention:

Queries

$$\mathbb{R}^{1 \times d_k} \ni \mathbf{q}_i = \mathbf{x}_i \mathbf{W}_Q$$

**Keys** Used as values to compare against the query:

Keys

$$\mathbb{R}^{1 \times d_k} \ni \mathbf{k}_i = \mathbf{x}_i \mathbf{W}_K$$

**Values** Used to determine the output:

Values

$$\mathbb{R}^{1 \times d_v} \ni \mathbf{v}_i = \mathbf{x}_i \mathbf{W}_V$$

where  $\mathbf{W}_Q \in \mathbb{R}^{d_{\text{model}} \times d_k}$ ,  $\mathbf{W}_K \in \mathbb{R}^{d_{\text{model}} \times d_k}$ , and  $\mathbf{W}_V \in \mathbb{R}^{d_{\text{model}} \times d_v}$  are parameters.

Then, the attention weights  $\alpha_{i,j}$  between two embeddings  $\mathbf{x}_i$  and  $\mathbf{x}_j$  are computed as:

$$\text{score}(\mathbf{x}_i, \mathbf{x}_j) = \frac{\mathbf{q}_i \mathbf{k}_j}{\sqrt{d_k}}$$

$$\alpha_{i,j} = \text{softmax}_j([\text{score}(\mathbf{x}_i, \mathbf{x}_1), \dots, \text{score}(\mathbf{x}_i, \mathbf{x}_T)])$$

The output  $\mathbf{a}_i \in \mathbb{R}^{1 \times d_v}$  is a weighted sum of the values of each token:

$$\mathbf{a}_i = \sum_t \alpha_{i,t} \mathbf{v}_t$$

To maintain the input dimension, a final projection  $\mathbf{W}_O \in \mathbb{R}^{d_v \times d_{\text{model}}}$  is applied.

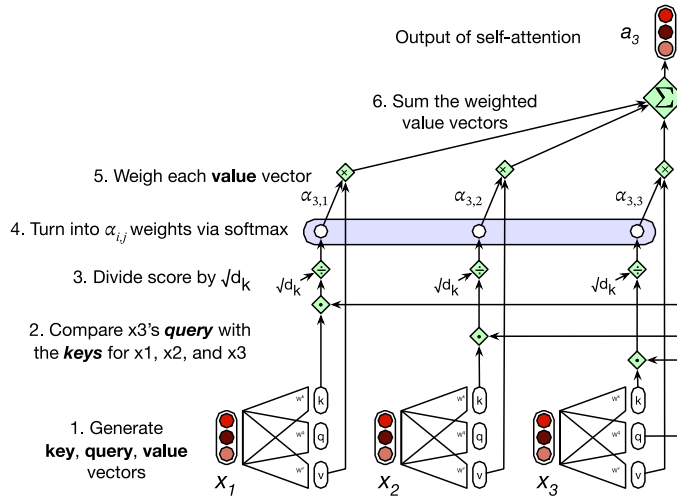

**Causal attention** Self-attention mechanism where only past tokens can be used to determine the representation of a token at a specific position. It is computed by modifying the standard self-attention as follows:

Causal attention

$$\forall j \leq i : \text{score}(\mathbf{x}_i, \mathbf{x}_j) = \frac{\mathbf{q}_i \cdot \mathbf{k}_j}{\sqrt{d_k}} \quad \forall j > i : \text{score}(\mathbf{x}_i, \mathbf{x}_j) = -\infty$$

$$\alpha_{i,j} = \text{softmax}_j([\text{score}(\mathbf{x}_i, \mathbf{x}_1), \dots, \text{score}(\mathbf{x}_i, \mathbf{x}_T)])$$

$$\mathbf{a}_i = \sum_{t:t \leq i} \alpha_{i,t} \mathbf{v}_t$$

		q1·k1	−∞	−∞	−∞
		q2·k1	q2·k2	−∞	−∞
		q3·k1	q3·k2	q3·k3	−∞
		q4·k1	q4·k2	q4·k3	q4·k4
N					
	N				

Figure 6.3.: Score matrix with causal attention

### 6.3.2. Embeddings

**Input embedding** The input is tokenized using standard tokenizers (e.g., BPE, SentencePiece, ...). Each token is then encoded using a learned embedding matrix.

Input embedding

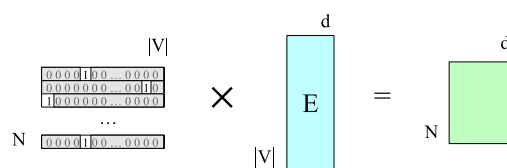

**Positional encoding** Learned position embeddings to encode positional information are added to the input token embeddings.

Positional encoding

**Remark.** Without positional encoding, transformers are invariant to permutations.

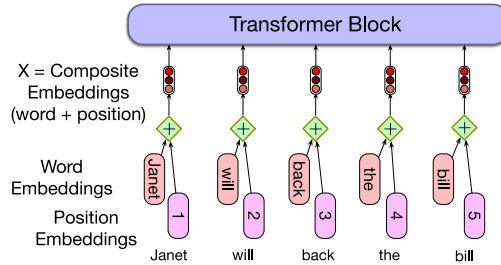

### 6.3.3. Transformer block

**Transformer block** Module with the same input and output dimensionality (i.e., allows stacking multiple blocks) composed of:

Transformer block

**Multi-head attention** Uses  $h$  different self-attention blocks with different queries, keys, and values. Value vectors are of size  $\frac{d_v}{h}$ . The final projection  $W_O$  is applied on the concatenation of the outputs of each head.

Multi-head attention

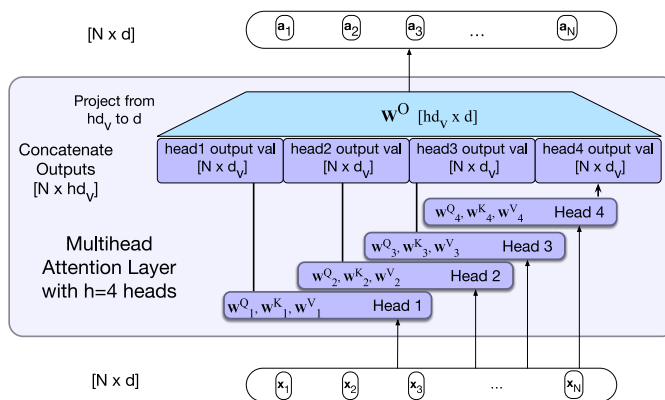

**Feedforward layer** Fully-connected 2-layer network applied at each position of the attention output:

$$\text{FFN}(x_i) = \text{ReLU}(x_i W_1 + b_1) W_2 + b_2$$

Where the hidden dimension  $d_{\text{ff}}$  is usually larger than  $d_{\text{model}}$ .

**Normalization layer** Applies layer normalization (i.e., normalize each sequence of the batch independently) to help training stability.

**Residual connection** Helps to propagate information during training.

**Remark** (Residual stream). An interpretation of residual connections is that of residual stream where the input token is enhanced by the output of multi-head attention and the feedforward network.

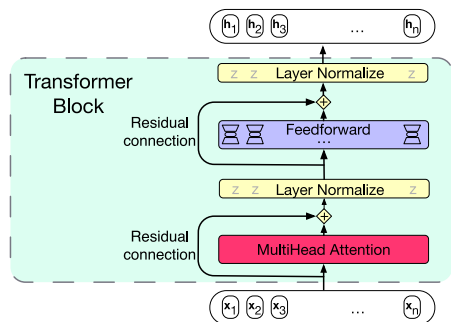
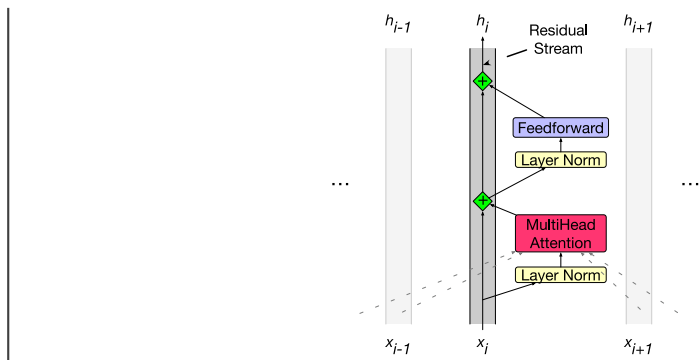
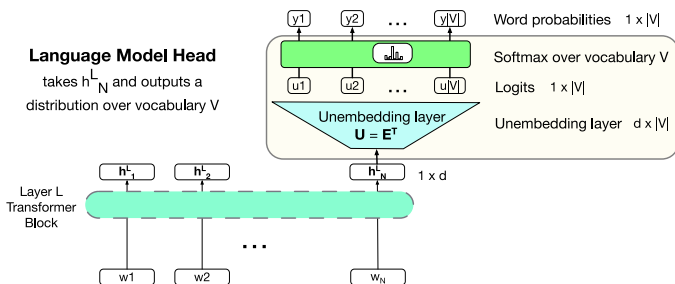

Figure 6.4.: Overall attention block

**Language modeling head** Takes as input the output corresponding to a token of the transformer blocks stack and outputs a distribution over the vocabulary.

Language modeling head



# 7. Large language models

## 7.1. Decoder-only architecture

**Conditional generation** Generate text conditioned on the input tokens (i.e., prompt).

Conditional generation

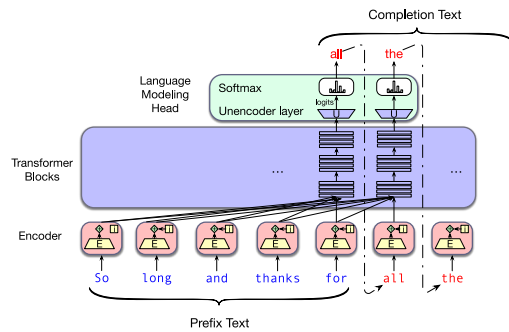

**Example** (Sentiment analysis). Given the prompt:

$p =$  the sentiment of the sentence 'I like Jackie Chan' is

Determine the probability of the tokens positive and negative:

$$\mathcal{P}(\text{positive} \mid p) \quad \mathcal{P}(\text{negative} \mid p)$$

**Example** (Question answering). Given the prompt:

$p =$  Q: who wrote the book 'The origin of Species'? A:

Determine the tokens of the answer autoregressively:

$$\arg \max_{w_1} \mathcal{P}(w_1 \mid p), \arg \max_{w_2} \mathcal{P}(w_2 \mid pw_1), \dots$$

### 7.1.1. Decoding strategies

**Greedy decoding** Select the next token as the most probable of the output distribution.

Greedy decoding

**Remark.** Greedy decoding risks getting stuck in a local optimum.

**Example.** Consider the following search tree of possible generated sequences:

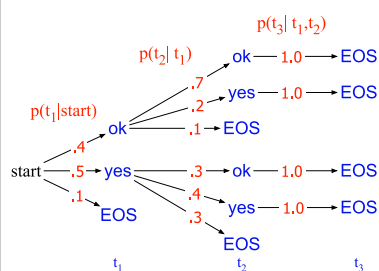

Greedy search would select the sequence **yes yes** which has probability  $0.5 \cdot 0.4 = 0.2$ . However, the sequence **ok ok** has a higher probability of  $0.4 \cdot 0.7 = 0.28$ .

**Beam search** Given a beam width  $k$ , perform a breadth-first search keeping at each branching level the top- $k$  tokens based on the probability of that sequence computed as:

$$\log(\mathcal{P}(y | x)) = \sum_{i=1}^t \log(\mathcal{P}(y_i | x, y_1, \dots, y_{i-1}))$$

**Example.** Consider the following tree with beam width  $k = 2$ :

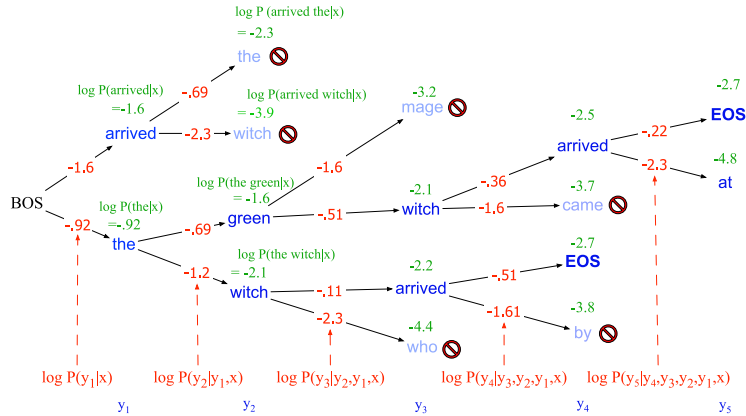

The selected sequence is [BOS] the green witch arrived [EOS].

**Remark.** As each path might generate sequences of different length, the score is usually normalized by the number of tokens as:

$$\log(\mathcal{P}(y | x)) = \frac{1}{t} \sum_{i=1}^t \log(\mathcal{P}(y_i | x, y_1, \dots, y_{i-1}))$$

**Remark.** The likelihood of the sequences generated using beam search is higher than using greedy decoding. However, beam search is still not optimal.

**Sampling** Sample the next token based on the output distribution.

**Random sampling** Sample considering the distribution over the whole vocabulary.

**Remark.** By adding-up all the low-probability words (which are most likely unreasonable as the next token), their actual chance of getting selected is relatively high.

**Temperature sampling** Skew the distribution to emphasize the most likely words and decrease the probability of less likely ones. Given the logits  $\mathbf{u}$  and the temperature  $\tau$ , the output distribution  $\mathbf{y}$  is determined as:

$$\mathbf{y} = \text{softmax}\left(\frac{\mathbf{u}}{\tau}\right)$$

where:

- Higher temperatures (i.e.,  $\tau > 1$ ) allow for considering low-probability words.
- Lower temperatures (i.e.,  $\tau \in (0, 1]$ ) focus on high-probability words.

**Remark.** For  $\tau \rightarrow 0$ , generation becomes closer to greedy decoding.

**Top-k sampling** Consider the top- $k$  most probable words and apply random sampling on their normalized distribution.

| **Remark.**  $k = 1$  corresponds to greedy decoding.

| **Remark.**  $k$  is fixed and does not account for the shape of the distribution.

**Top-p/nucleus sampling** Consider the most likely words such that their probability mass adds up to  $p$ . Then, apply random sampling on their normalized distribution.

### 7.1.2. Pre-training

**Pre-training** Use self-supervision and teacher forcing to train the whole context window in parallel on a large text corpus. Pre-training

| **Remark.** Results are highly dependent on the training corpora. Important aspects to consider are:

| **Language** Most of the available data is in English.

| **Data quality** Prefer high-quality sources such as Wikipedia or books. Boilerplate removal and deduplication might be needed.

| **Safety filtering** Toxicity removal might be needed

| **Ethical and legal issues** Use of copyrighted material, permission from data owners, use of private information, ...

**Scaling laws** Empirical laws that put in relationship: Scaling laws

- Non-embedding parameters  $N$  ( $N \approx 2d_{\text{model}}m_{\text{layer}}(2d_{\text{attention}} + d_{\text{ff}})$ ),
- Training data size  $D$ ,
- Compute budget  $C$  (i.e., training iterations).

By keeping two of the three factors constant, the loss  $\mathcal{L}$  of an LLM can be estimated as a function of the third variable:

$$\mathcal{L}(N) = \left(\frac{N_c}{N}\right)^{\alpha_N} \quad \mathcal{L}(D) = \left(\frac{D_c}{D}\right)^{\alpha_D} \quad \mathcal{L}(C) = \left(\frac{C_c}{C}\right)^{\alpha_C}$$

where  $N_c$ ,  $D_c$ ,  $C_c$ ,  $\alpha_N$ ,  $\alpha_D$ , and  $\alpha_C$  are constants determined empirically based on the model architecture.

### 7.1.3. Fine-tuning

**Fine-tuning** Specialize an LLM to a specific domain or task. Fine-tuning

**Continued pre-training** Continue pre-training with a domain-specific corpus. Continued pre-training

**Model adaptation** Specialize a model by adding new learnable parameters.

**Task-specific fine-tuning** Add a new trainable head on top of the model. Task-specific fine-tuning

**Parameter-efficient fine-tuning (PEFT)** Continue training a selected subset of parameters (e.g., LoRA in Section 8.1). Parameter-efficient fine-tuning (PEFT)

**Supervised fine-tuning** Continue training using a supervised dataset to align the model to human's expectation. Supervised fine-tuning

## 7.2. Encoder-only architecture

**Transformer encoder** Architecture that produces contextual embeddings by considering both left-to-right and right-to-left context.

Transformer encoder

**Remark.** This architecture performs feature extraction and is more suited for classification tasks.

**Architecture** Similar to a transformer decoder, but self-attention is not causal.

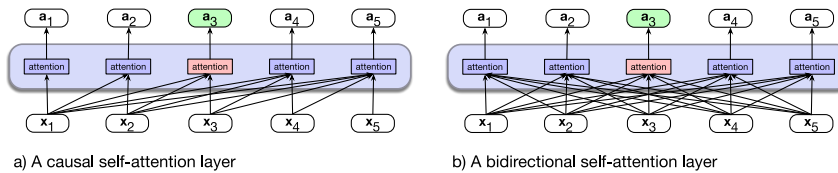

**Contextual embedding** Represent the meaning of word instances (i.e., in a dynamic manner depending on the surroundings).

Contextual embedding

**Remark** (Sequence embedding). Encoders usually have a classifier token (e.g., [CLS]) to model the whole sentence.

**Example** (Word sense disambiguation). Task of determining the sense of each word of a sequence. Senses usually come from an existing ontology (e.g., WordNet). An approach to solve the problem is the following:

1. Compute the embeddings  $\mathbf{v}_i$  of the words using a pre-trained encoder (e.g., BERT).
2. Represent the embedding of a sense as the average of the tokens of that sense:

$$\mathbf{v}_s = \frac{1}{n} \sum_i \mathbf{v}_i$$

3. Predict the sense of a word  $\mathbf{t}$  as:

$$\arg \max_{s \in \text{senses}(\mathbf{t})} \text{distance}(\mathbf{t}, \mathbf{v}_s)$$

**Tokenizer fertility** Average amount of tokens used to represent words.

Tokenizer fertility

**Remark.** Tokenizer fertility is relevant for inference speed.

**Curse of multilinguality** The performance of each language of a multilingual model tend to be worse than its monolingual counterpart.

Curse of multilinguality

### 7.2.1. Pre-training

**Masked language modeling** Task of predicting missing or corrupted tokens in a sequence.

Masked language modeling

**Remark.** Transformer encoders output embeddings. For training purposes, a head to output a distribution over the vocabulary is added.

**Example.** Given a training corpus, BERT is trained by randomly sampling 15% of the tokens in the training data and either:

- Mask it with a special [MASK] token (80% of the time).



- Replace it with a different token (10% of the time).
- Do nothing (10% of the time).

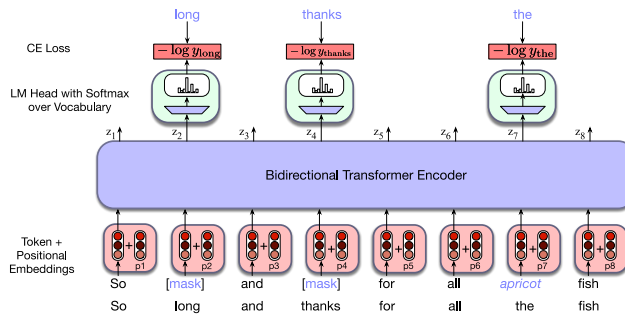

**Remark.** BERT’s training approach is inefficient as masks are determined before training and only 15% of the corpus tokens are actually used for training. Other models (e.g., RoBERTa), dynamically determine the mask at training time, allowing for more variety.

**Span masking** Mask contiguous spans of words to obtain a harder training objective.

Span masking

**Remark.** This approach generally produces better embeddings.

### 7.2.2. Fine-tuning

**Fine-tuning for classification** Add a classification head on top of the classifier token.

**Fine-tuning for sequence-pair classification** Use a model pre-trained to process pair of sequences. This is usually done by means of a special separator token (e.g., [SEP] in BERT).

**Fine-tuning for sequence labeling** Add a classification head on top of each token. A conditional random field (CRF) layers can also be added to produce globally more coherent tags.

**Example** (Named entity recognition (NER)). Task of assigning to each word of a sequence its entity class. NER taggers usually also capture concepts spanning across multiple tokens. To achieve this, additional information is provided with the entity class:

**Begin** Starting token of a concept.

**Inside** Token belonging to the same span of the previous one.

**End** Last token of a span.

**Outside** Token outside the scope of the tagger.

#### Metrics

$$\text{Recall} = \frac{\text{Correctly labeled responses}}{\text{Total that should have been labeled}}$$

$$\text{Precision} = \frac{\text{Correctly labeled responses}}{\text{Total that has been labeled}}$$

**Remark.** The entity (so, also a span of text) is the atomic unit for NER metrics.

**Remark (GLUE).** The General Language Understanding Evaluation (GLUE) benchmark is a common set of tasks used to evaluate natural language understanding models. It comprises tasks based on single sentences, multiple sentences, and inference from a sequence.

### 7.3. Encoder-decoder architecture

**Encoder-decoder architecture** Model with both an encoder and decoder:

Encoder-decoder architecture

**Encoder** Architecture as presented in Section 7.2. Its result is used to condition the output of the decoder.

**Decoder** Architecture similar to the one presented in Section 7.1 with an additional cross-attention layer inserted before causal attention.

**Cross-attention** Attention layer that uses the output of the encoder as keys and values, while the query is from the decoder.

Cross-attention

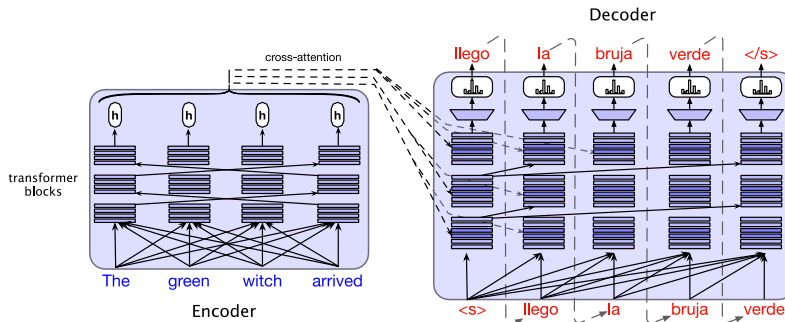

#### 7.3.1. Pre-training

**Span corruption** Given an input sequence, replace different-length spans of text with a unique placeholder. The encoder takes as input the corrupted sequence, while the decoder has to predict the missing words.

Span corruption

**Remark.** It has been observed that targeted span masking works better compared to random span masking.

**Example.** Given the sequence:

<bos> thank you for inviting me to your party last week <eos>

Some spans of text are masked with placeholder tokens as follows:

<bos> thank you <X> me to your party <Y> week <eos>

The masked sequence is passed through the encoder, while the decoder has to predict the masked tokens:

<bos> <X> for inviting <Y> last <Z> <eos>

# 8. Efficient model utilization

## 8.1. Low-rank adaptation

**Low-rank adaptation (LoRA)** Method to update weights by learning an offset that uses fewer parameters.

Low-rank adaptation (LoRA)

Consider a weight matrix  $W \in \mathbb{R}^{d \times k}$ , LoRA decomposes the update into two learnable matrices  $A \in \mathbb{R}^{d \times r}$  and  $B \in \mathbb{R}^{r \times k}$  (with  $r \ll d, k$ ). Weights update is performed as:

$$W_{\text{fine-tuned}} = W_{\text{pre-trained}} + AB$$

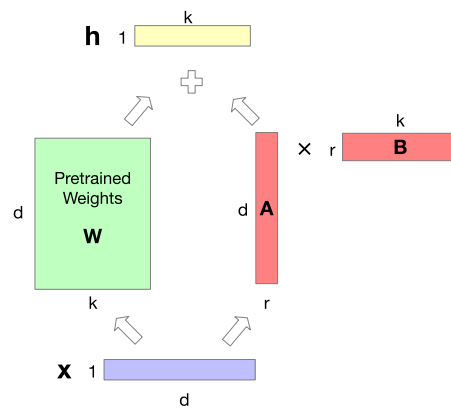

## 8.2. Model compression

### 8.2.1. Parameters compression

**Parameter sharing** Use the same parameters between layers.

Parameter sharing

**Pruning** Remove weights with small impact on the loss.

Pruning

**Remark.** Dropping some weights produce sparse matrices that are unoptimized for parallel hardware. Therefore, this approach does not always improve efficiency.

**Quantization** Store and perform operations with lower precision floating-points (e.g., FP32 to FP4).

Quantization

### 8.2.2. Training compression

**Mixture of experts** Specialize smaller models on subsets of data and train a router to forward the input to the correct expert.

Mixture of experts

**Remark.** This approach can be easily deployed on distributed systems.

**Knowledge distillation** Train a student model to emulate the teacher's hidden states. In a general setting, the output distribution of the teacher is used to create the student. Two losses are used:

Knowledge distillation

**Distillation loss** Matches the output distribution of the student to the one of the teacher. A softmax with higher temperature is usually used so that training contribution does not only come from the highest probability.

**Student loss** Matches the output distribution of the student with the ground-truth (i.e., same loss of the training task).

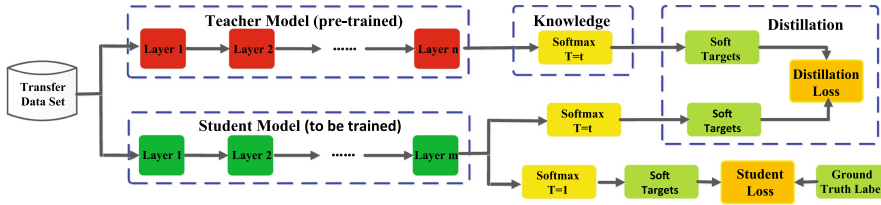

**Vocabulary transfer** Use a domain-specific tokenizer to reduce the number of tokens to represent complex/domain-specific words and reduce the size of the embedding matrix.

Vocabulary transfer

**Fast vocabulary transfer (FVT)** Given:

- A starting embedding model with tokenizer  $\mathcal{T}_s$ , vocabulary  $V_s$ , and embedding matrix  $E_s$ ,
- A new tokenizer  $\mathcal{T}_{\text{dom}}$  trained on a domain-specific corpus,

Fast vocabulary transfer (FVT)

The embedding matrix  $E_{\text{dom}}$  for the vocabulary  $V_{\text{dom}}$  of  $\mathcal{T}_{\text{dom}}$  is built as follows:

$$\forall t_i \in V_{\text{dom}} : E_{\text{dom}}(t_i) = \frac{1}{|\mathcal{T}_s(t_i)|} \sum_{t_j \in \mathcal{T}_s(t_i)} E_s(t_j)$$

In other words, each token in  $V_{\text{dom}}$  is encoded as the average of the embeddings of the tokens that compose it in the starting embedding model (if the token appear in both vocabularies, the embedding is the same).

### 8.3. In-context learning

**Prompting** Pass a prompt to the language model to condition generation.

Prompting

More formally, a prompt is defined by means of a prompting function  $f_{\text{prompt}}(\cdot)$  that formats an input text  $x$ .  $f_{\text{prompt}}$  typically has a slot for the input and a slot for the answer (e.g., the class in case of classification). The prompt is then fed to the language model that searches the highest scoring word  $\hat{z}$  to fill the answer as follows:

$$\hat{z} = \arg \max \mathcal{P}(f_{\text{fill}}(f_{\text{prompt}}(x), z); \theta)$$

Where  $f_{\text{fill}}(f_{\text{prompt}}(x), z)$  inserts  $z$  in the prompt. In other word, we are looking for the word that makes the model least perplexed.

**Example.** A prompt for sentiment analysis of movie reviews might be:

[X] Overall, it was a [Z] movie.

Where [X] is the placeholder for the review and [Z] is for the class.

**Remark.** The prompt does not necessarily need to be text (i.e., discrete/hard prompts). Continuous/soft prompts (i.e., embeddings) can also be used to condition

|generation.

**Zero-shot learning** Solve a task by providing a language model the description of the problem in natural language. Zero-shot learning

**One-shot learning** Solve a task by providing a language model the description of the problem in natural language and a single demonstration (i.e., an example). One-shot learning

**Few-shot learning** Solve a task by providing a language model the description of the problem in natural language and a few demonstrations. Few-shot learning

**Remark.** Empirical results show that not too many examples are required. Also, too many examples might reduce performance.

**Remark.** Some studies show that an explanation for in-context learning is that causal attention has the same effect of gradient updates (i.e., the left part of the prompt influences the right part).

Another possible explanation is based on the concept of induction heads which are attention heads that specialize in predicting repeated sequences (i.e., in-context learning is seen as the capability of imitating past data). Ablation studies show that by identifying and removing induction heads, the in-context learning performance of a model drastically drops.

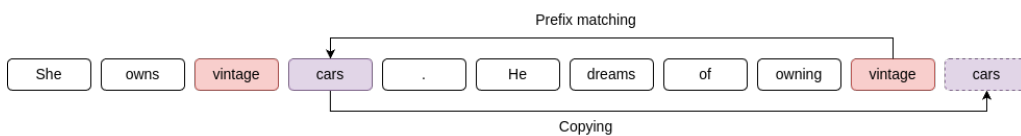
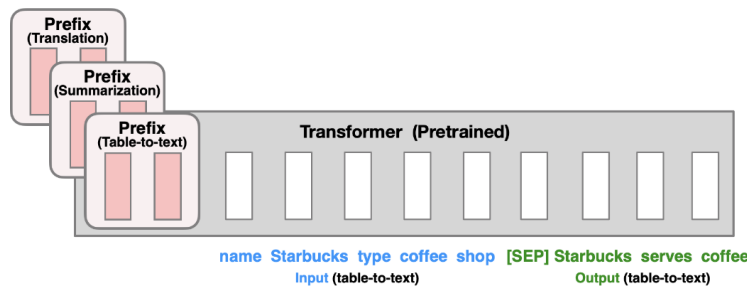

Figure 8.1.: Example of induction head

**Prefix-tuning** Soft prompting technique that learns some prefix embeddings for a specific task to add to the prompt while keeping the rest of the model frozen. Prefix-tuning



**Chain-of-thought prompting** Provide in the prompt examples of reasoning to make the model generate the output step-by-step<sup>1</sup>. Chain-of-thought prompting

**Remark.** Empirical results show that the best prompt for chain-of-thought is to add to the prompt **think step by step**.



1

# 9. Language model alignment and applications

## 9.1. Model alignment

**Remark.** Off-the-shelf pre-trained models tend to only be good at word completion. They are most likely unable to understand instructions and might generate harmful content.

### 9.1.1. Instruction tuning

**Instruction tuning** Fine-tune a model on a dataset containing various tasks expressed in natural language in the form (description, examples, solution), all usually formatted using multiple templates.

Instruction tuning

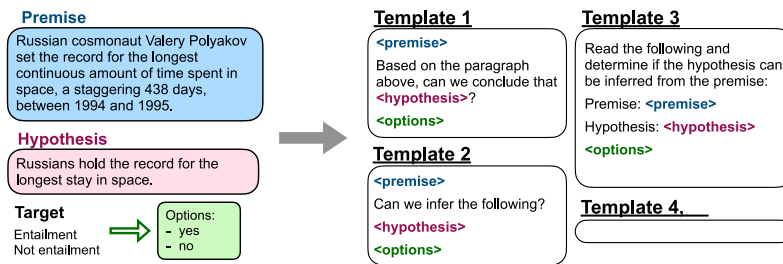

Figure 9.1.: Example of templates for entailment detection

**Remark.** If done correctly, after performing instruction tuning on a model, it should be able to also solve tasks that were not present in the tuning dataset.

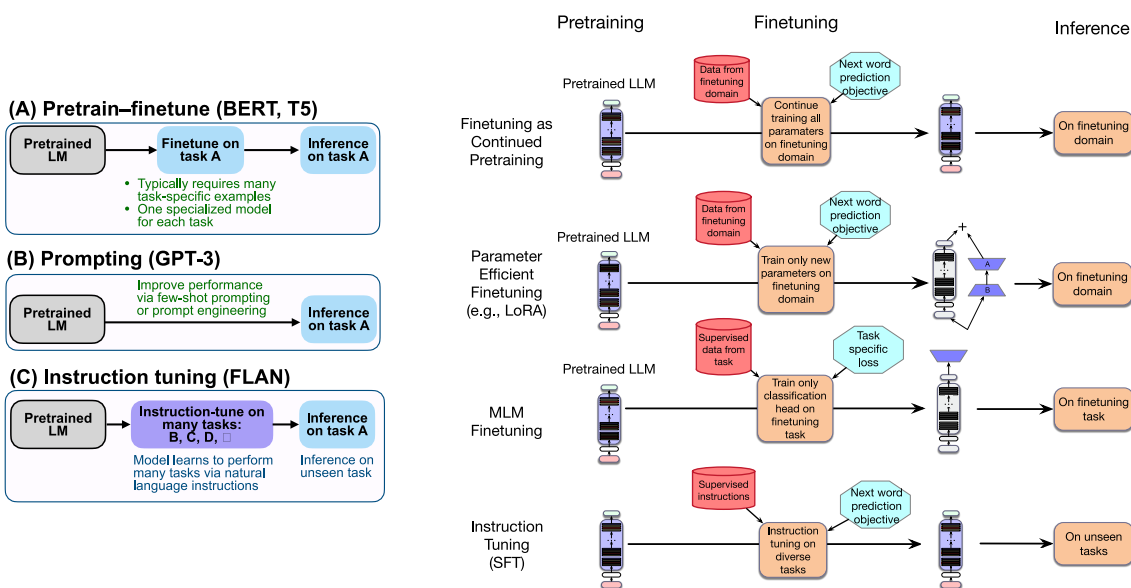

Figure 9.2.: Comparison of tuning approaches

### 9.1.2. Preference alignment

**Preference alignment** Align the output of a model with human values.

Preference alignment

**Reinforcement learning with human feedback (RLHF)** Align a language model using a policy-gradient reinforcement learning algorithm. The problem can be formulated as follows:

Reinforcement learning with human feedback (RLHF)

- The policy to learn represents the aligned model (i.e., **prompt**  $\mapsto$  **answer** model),
- Prompts are the states,
- Answers are the actions.

RLHF works as follows:

1. Start from a pre-trained language model that already works well.
2. Train a reward model  $r_\theta$  from a human-annotated dataset that maps text sequences into rewards. The architecture is usually based on transformers.
3. Fine-tune the language model (i.e., train the policy) using an RL algorithm (e.g., PPO) and the learned reward model.

Given a prompt  $x$  and an answer  $y$ , the reward  $r$  used for the RL update is computed as:

$$r = r_\theta(y | x) - \lambda_{\text{KL}} D_{\text{KL}}(\pi_{\text{PPO}}(y | x) || \pi_{\text{base}}(y | x))$$

where:

- $r_\theta(y | x)$  is the reward provided by the reward model.
- $-\lambda_{\text{KL}} D_{\text{KL}}(\pi_{\text{PPO}}(y | x) || \pi_{\text{base}}(y | x))$  is a penalty based on the Kullback-Leibler divergence to prevent the aligned model  $\pi_{\text{PPO}}$  from moving too away from the original model  $\pi_{\text{base}}$  (i.e., prevent the loss of language capabilities).

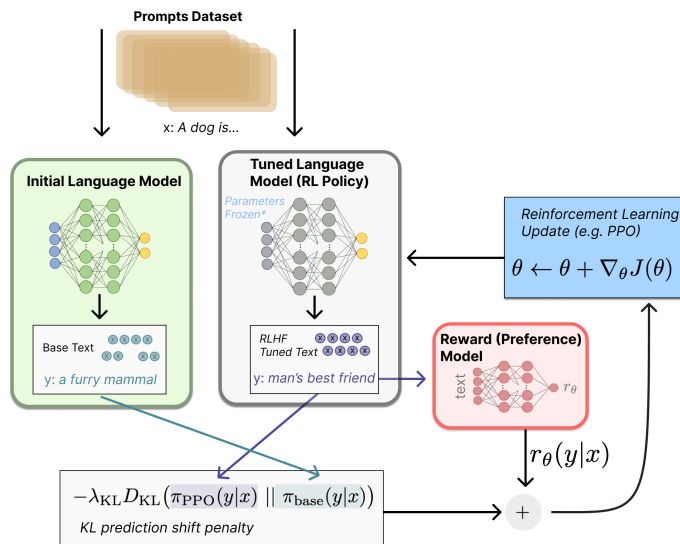

# 10. Retrieval augmented generation (RAG)

## 10.1. Information retrieval

**Ad-hoc retrieval** Given a query, provide an ordered list of relevant documents from some (unstructured) collection. Ad-hoc retrieval

To determine relevancy, query and documents are embedded in some form and compared with a distance metric.

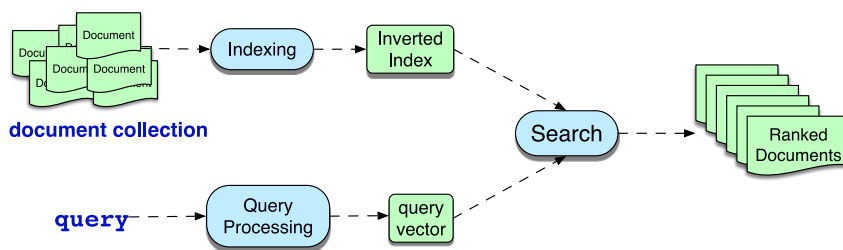

**Inverted index** Mapping from terms to documents with pre-computed term frequencies (and/or term positions). It allows narrowing down the document search space by considering only those that match the terms in the query. Inverted index

### 10.1.1. Document embeddings

**TF-IDF embedding** Embed a document using the TF-IDF weighted term-document matrix. TF-IDF embedding

**Document scoring** Given a document  $d$ , a query  $q$ , and their respective embeddings  $\mathbf{d}$  and  $\mathbf{q}$ , their similarity score is computed as their cosine similarity:

$$\begin{aligned} \text{score}(q, d) &= \frac{\mathbf{q} \cdot \mathbf{d}}{|\mathbf{q}| \cdot |\mathbf{d}|} \\ &= \sum_{t \in q} \left( \frac{\text{tf-idf}(t, q)}{\sqrt{\sum_{q_i \in q} \text{tf-idf}^2(q_i, q)}} \cdot \frac{\text{tf-idf}(t, d)}{\sqrt{\sum_{d_i \in d} \text{tf-idf}^2(d_i, d)}} \right) \end{aligned}$$

As query terms tend to have count 1 (i.e.,  $\forall t \in q : \text{tf-idf}(t, q) \approx \text{idf}(t)$ , which is already present in  $\text{tf-idf}(t, d)$ ),  $\text{tf-idf}(t, q)$  can be dropped together with its normalization factor  $|\mathbf{q}|$  (which is the same for all documents). Then, the score can be simplified and approximated to:

$$\text{score}(q, d) = \sum_{t \in q} \frac{\text{tf-idf}(t, d)}{|\mathbf{d}|} = \sum_{t \in q} \frac{\text{tf-idf}(t, d)}{\sqrt{\sum_{d_i \in d} \text{tf-idf}^2(d_i, d)}}$$

**Example.** Given:

- The query  $q = \text{sweet love}$ ,



- The documents:

$d_1 = \text{sweet sweet nurse! love?}$   
 $d_2 = \text{sweet sorrow}$   
 $d_3 = \text{how sweet is love?}$   
 $d_4 = \text{nurse!}$

The embeddings of  $q$  and  $d_1$  are computed as follows:

Word	Count	tf	tf-idf	tf-idf/ q	Count	tf	tf-idf	tf-idf/ d <sub>1</sub>
sweet	1	1.000	0.125	0.383	2	1.301	0.163	0.357
nurse	0	0	0	0	1	1.000	0.301	0.661
love	1	1.000	0.301	0.924	1	1.000	0.301	0.661
how	0	0	0	0	0	0	0	0
sorrow	0	0	0	0	0	0	0	0
is	0	0	0	0	0	0	0	0

$|q| = \sqrt{0.125^2 + 0.301^2} = 0.326$        $|d_1| = \sqrt{0.163^2 + 0.301^2 + 0.301^2} = 0.456$

The overall score is therefore:

$$\text{score}(q, d_1) = (0.383 \cdot 0.357) + (0.924 \cdot 0.610) = 0.137 + 0.610 = 0.747$$

By using the simplified formula, we have that:

Document	d <sub>i</sub>	tf-idf(sweet)	tf-idf(love)	score
$d_1$	0.456	0.163	0.301	1.017
$d_2$	0.615	0.125	0	0.203
$d_3$	0.912	0.125	0.301	0.467
$d_4$	0.301	0	0	0

**Okapi BM25** TF-IDF variant with two additional parameters:

Okapi BM25

- $k$  to balance between **tf** and **idf**,
- $b$  to weigh the importance of document length normalization.

It is defined as follows:

$$\text{BM25}(q, d) = \sum_{t \in q} \left( \text{idf}(t) \frac{\text{tf}(t, d) \cdot (k + 1)}{k \cdot \left(1 - b + b \frac{|d|}{|d_{\text{avg}}|}\right) + \text{tf}(t, d)} \right)$$

where  $|d_{\text{avg}}|$  is the average document length, and typically  $k \in [1.2, 2]$  and  $b = 0.75$ .

**Dense embedding** Embed a document using a pre-trained encoder (e.g., BERT).

Dense embedding

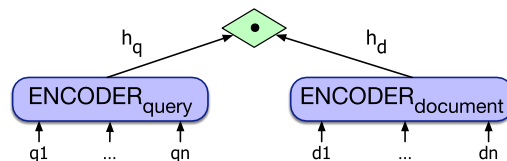

**Document scoring** Use nearest neighbor with the dot product as distance. To speed-up search, approximate k-NN algorithms can be used.

### 10.1.2. Metrics

**Precision/recall** Given:

Precision/recall

- The set of documents returned by the system  $T$ ,
- The selected relevant documents  $R \subseteq T$ ,
- The selected irrelevant documents  $N \subseteq T$ ,
- All the relevant documents  $U \supseteq R$ .

Precision and recall are computed as:

$$\text{precision} = \frac{|R|}{|T|} \quad \text{recall} = \frac{|R|}{|U|}$$

**Precision-recall curve** Given a ranked list of documents, plot recall and precision by considering an increasing number of documents.

Precision-recall curve

**Interpolated precision** Smoothed version of the precision-recall curve.

Consider recalls at fixed intervals and use as precision at position  $r$  the maximum of all the next ones:

$$\text{precision}_{\text{interpolated}}(r) = \max_{i \geq r} \text{precision}(i)$$

**Average precision** Average precision by considering the predictions up to a cut-off threshold  $t$ . Given the relevant documents  $R_t$  in the first  $t$  predictions, average precision is computed as:

Average precision

$$\text{AP}_t = \frac{1}{|R_t|} \sum_{d \in R_t} \text{precision}_t(d)$$

where  $\text{precision}_t(d)$  is computed w.r.t. the position of the document  $d$  in the ranked list.

**Mean average precision** Average AP over different queries  $Q$ :

Mean average precision

$$\text{mAP}_t = \frac{1}{|Q|} \sum_{q \in Q} \text{AP}_t(q)$$

**Example.** Consider the following ranked predictions:

Rank	Relevant?	Precision <sub>t</sub>	Recall <sub>t</sub>	Rank	Relevant?	Precision <sub>t</sub>	Recall <sub>t</sub>
1	Y	1.0	0.11	14	N	0.43	0.66
2	N	0.50	0.11	15	Y	0.47	0.77
3	Y	0.66	0.22	16	N	0.44	0.77
4	N	0.50	0.22	17	N	0.44	0.77
5	Y	0.60	0.33	18	Y	0.44	0.88
6	Y	0.66	0.44	19	N	0.42	0.88
7	N	0.57	0.44	20	N	0.40	0.88
8	Y	0.63	0.55	21	N	0.38	0.88
9	N	0.55	0.55	22	N	0.36	0.88
10	N	0.50	0.55	23	N	0.35	0.88
11	Y	0.55	0.66	24	N	0.33	0.88
12	N	0.50	0.66	25	Y	0.36	1.00
13	N	0.46	0.66				

The precision-recall curve is the following:

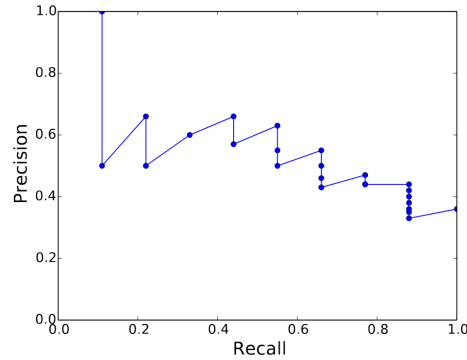

Interpolated with 11 equidistant recall points, the curve is:

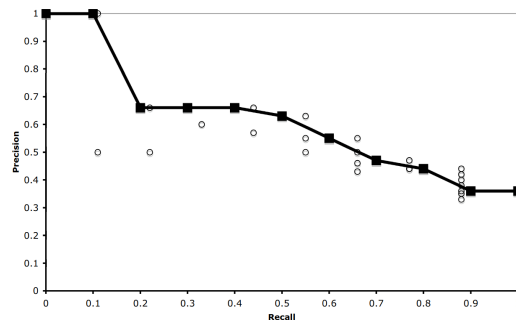

Average precision computed over all the predictions (i.e.,  $t = 25$ ) is:

$$AP = \frac{1.0 + 0.66 + 0.60 + 0.66 + 0.63 + 0.55 + 0.47 + 0.44 + 0.36}{9} = 0.6$$

## 10.2. Question answering

### 10.2.1. Reading comprehension task

**Reading comprehension task** Find a span of text in the document that answers a given question.

Reading comprehension task

More formally, given a question  $q$  and a passage  $p = p_1, \dots, p_m$ , the following is computed for all tokens  $p_i$ :

- The probability  $\mathcal{P}_{\text{start}}(i)$  that  $p_i$  is the start of the answer span.
- The probability  $\mathcal{P}_{\text{end}}(i)$  that  $p_i$  is the end of the answer span.

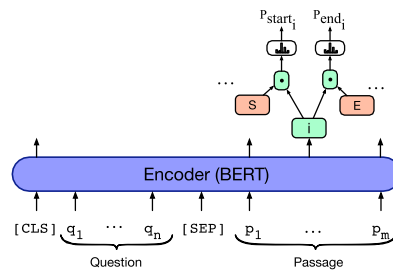

Figure 10.1.: Example of span labeling architecture

**Remark.** A sliding window over the whole passage can be used if it is too long for the context length of the model.

**Remark.** The classification token [CLS] can be used to determine whether there is no answer.

### 10.2.2. Metrics

**Exact match** Ratio of match between predicted answer and the ground-truth computed considering the characters at each position. Exact match

**F1 score** Macro F1 score computed by considering predictions and ground-truth as bag of tokens (i.e., average token overlap). F1 score

**Mean reciprocal rank** Given a system that provides a ranked list of answers to a question  $q_i$ , the reciprocal rank for  $q_i$  is: Mean reciprocal rank

$$\text{RR} = \frac{1}{\text{rank}_i}$$

where  $\text{rank}_i$  is the index of the first correct answer in the provided ranked list. Mean reciprocal rank is computed over a set of queries  $Q$ :

$$\text{mRR} = \frac{1}{|Q|} \sum_{i=1}^{|Q|} \frac{1}{\text{rank}_i}$$

### 10.2.3. Retrieval-augmented generation for question answering

**Remark.** Question answering with plain LLM prompting only is subject to the following problems:

- Hallucinations.
- It is limited to the training data and cannot integrate a new knowledge base.
- Its knowledge might not be up-to-date.

**RAG for QA** Given a question and a collection of documents, the answer is generated in two steps by the following components: RAG for QA

**Retriever** Given the question, it returns the relevant documents.

**Remark.** The retriever should be optimized for recall.

**Remark.** A more complex pipeline can be composed of:

**Rewriter** Rewrites the question into a better format.

**Retriever** Produces a ranked list of relevant documents.

**Reranker** Reorders the retrieved documents for a more fine-grained ranking.

**Reader** Given the question and the relevant documents, it uses a backbone LLM to generate the answer through prompting.

**Remark.** The current trend is to evaluate RAG performance with another LLM.

**Remark.** The collection of documents can also be a collection of passages or chunks of predetermined length.

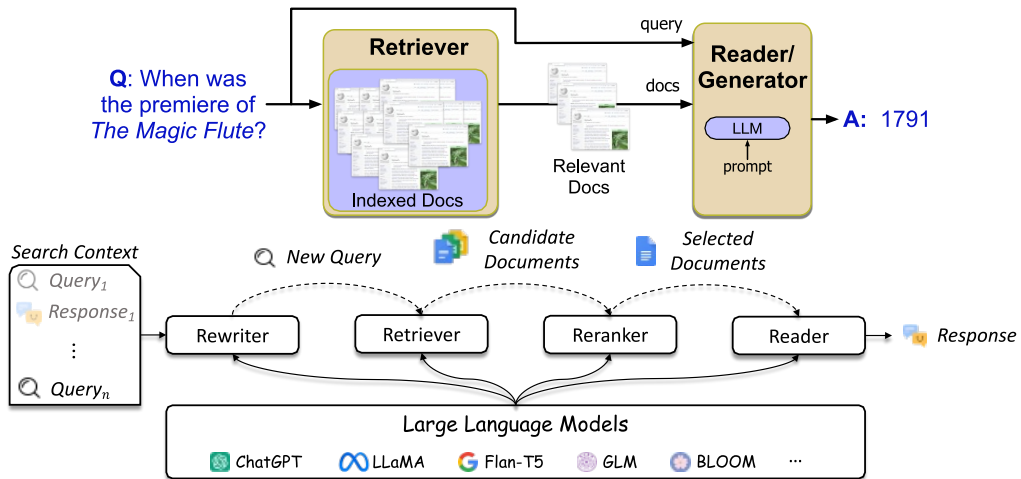

# A. Task-oriented dialog systems

## A.1. Human dialogs

<b>Natural language dialog</b>	Sequence of utterances (i.e., sentences) between two or more participants where each takes a turn.	Natural language dialog
<b>Turn-taking problem</b>	Determine when the turn of another participant ended.	Turn-taking problem
<b>Speech/dialog act</b>	Indicates the type of utterance.	Speech/dialog act
	<b>Example.</b> Yes-no question, declarative question, statement, appreciation, yes answer, ...	
	<b>Adjacency pairs</b> Speech acts that commonly appear together.	
	<b>Example.</b> Question → answer.	
	<b>Subdialog</b> Dialogs opened and closed within a dialog.	
	<b>Example.</b> Correction subdialog, clarification subdialog, ...	
<b>Dialog slot</b>	Relevant entities and properties of an utterance.	Dialog slot
	<b>Filler</b> Values assigned to a slot.	
<b>Conversation initiative</b>	Who initiates the dialog.	Conversation initiative
	<b>User initiative</b> The user asks questions and the system responds (e.g., FAQ).	
	<b>System initiative</b> The system asks questions to the user (e.g., form completion).	
	<b>Mixed initiative</b> Both the user and the system can ask questions.	
<b>Types of dialog</b>		Types of dialog
	<b>Information seeking</b> To retrieve information.	
	<b>Task-oriented</b> Dialog to achieve a goal.	
	<b>Argumentative</b> Argument in support or against an opinion.	
	<b>Explanatory</b> Teacher-student type of dialog.	
	<b>Recommendation</b> Persuasion dialog.	
	<b>Chit-chat</b> Free conversation.	

## A.2. Task-oriented dialogs

### A.2.1. Architectures

<b>Traditional dialog system</b>	The main components of an artificial dialog system are:	Traditional dialog system
----------------------------------	---	---------------------------

**Natural language understanding (NLU)** Extract the relevant information such as dialog acts and slot-fillers from the utterance.

Natural language understanding (NLU)

| **Remark.** This task can be seen as a named entity recognition problem.

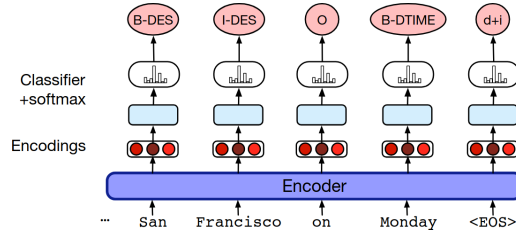

Figure A.1.: Example of neural architecture for slot filling

**Dialog state tracker (DST)** Maintains the history of the dialog. This component should also have access to a knowledge-base.

Dialog state tracker (DST)

**Dialog policy manager** Produces the dialog acts that composes the response from the output of the DST.

Dialog policy manager

**Natural language generation (NLG)** Produces a natural language utterance from the dialog acts produced by the dialog manager.

Natural language generation (NLG)

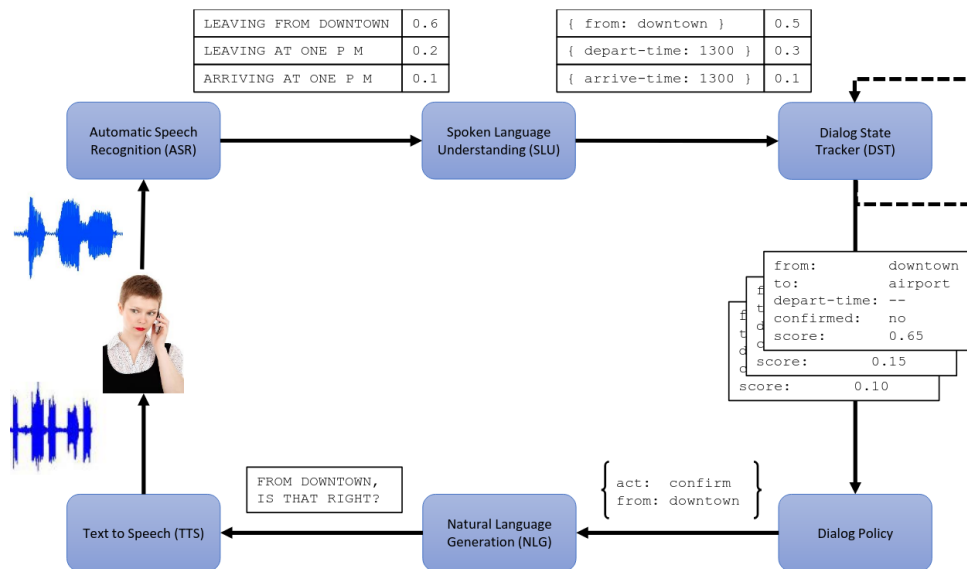

Figure A.2.: Example of components for a spoken dialog system

**LLM for dialog system** Use a language model that takes as input the utterance and directly produces a response.

LLM for dialog system

### A.2.2. Dataset

**MultiWOZ** Collection of human-human conversations over multiple domains and topics annotated with dialog states (i.e., turns), slots, and acts.

MultiWOZ

The dataset also defines an ontology for slots and a knowledge-base.

**Remark.** Human annotations are determined by agreement between multiple annotators.

**Remark.** The type of dialogs in the dataset sensibly affects the resulting dialog system.

**Example.** Wizard of Oz collection is a part of MultiWOZ that consists of question-answer dialogs between a user and a wizard. Dialogs produced based on these might result too artificial.

## A.3. Research topics

### A.3.1. LLM domain portability

**Domain portability** Adapt a model to a new domain (i.e., knowledge-base).

Domain portability

Possible approaches are:

**Fine-tuning** Fine-tune the LLM with the new knowledge-base.

**Remark.** This approach is susceptible to the catastrophic forgetting problem.

**Prompting** Embed the new knowledge-base into the prompt of the LLM.

**Remark.** This approach risks hallucinations and is constrained to the limits of the context length and computational inefficiency.

**Functional calling** Let the LLM query the knowledge-base when needed.

**Remark.** This approach requires more complex prompts and not all LLMs support it.

**Remark.** Experimental results show that functional calling works better than embedding the KB in the prompt. It is also more effective when the KB becomes bigger.

### A.3.2. LLM pragmatics

**Pragmatics** Ability to adapt a conversation based on the context.

Pragmatics

**Proactivity** Ability of providing useful but not explicitly requested information.

Proactivity

**Remark.** An LLM can be made more proactive by prompting or fine-tuning.

### A.3.3. LLM for dialog generation

**Automatic dialog generation** Use an LLM to generate and annotate dialogs to create a synthetic dataset. A possible approach is based on the following steps:

Automatic dialog generation

**Generation** Use the LLM to generate a dialog. Possible approaches are:

**One-pass** Prompt the LLM to generate a dialog based on a few references.

**Interactive** Produce a dialog by conversing with the model.

**Teacher-student** Let two LLMs converse.

**Annotation** Prompt the LLM to annotate the generated dialog based on some schema.

**Evaluation** Evaluate based on human opinion.



# B. Speech processing

## B.1. Audio representation

**Sound/soundwave** Vibration that travels through a medium. It is modulated by:

Soundwave

**Pitch** Frequency of the vibrations.

**Loudness** Amplitude of the vibrations.

**Waveform** Representation of a soundwave. It is described by:

Waveform

**Frequency** Represents the pitch of the sound.

**Period** Distance between two peaks of the sound (i.e., correlated to frequency as  $f = \frac{1}{T}$ ).

**Amplitude** Represents the loudness of the sound (i.e., the air pressure).

**Remark.** In practice, amplitude is usually converted in decibels due to the fact that the human auditory system perceives sound closer to a logarithmic scale.

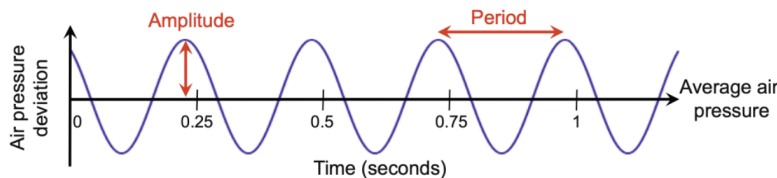

**Signal** Representation of information.

Signal

**Remark.** In sound processing, the waveform itself is the signal.

**Analog signal** Waveform as-is in the real world.

Analog signal

**Digital signal** Sampled (i.e., measure uniform time steps) and quantized (i.e., discretize values) version of an analog waveform.

Digital signal

**Fourier transform** Method to decompose a continuous signal in its constituent sin waves.

Fourier transform

Given a continuous signal  $x(t)$ , its Fourier transform is:

$$X(f) = \int_{-\infty}^{+\infty} x(t)e^{-j2\pi ft} dt$$

where  $X(f)$  indicates how much of the frequency  $f$  exists in  $x(t)$ .

**Discrete Fourier transform (DFT)** Fourier transform for digital signals.

Discrete Fourier transform (DFT)

Given a discrete signal  $x[n]$ , its DFT is:

$$X[k] = \sum_{n=0}^{N-1} x[n]e^{-\frac{j2\pi kn}{N}}$$

where  $k$  is the discrete frequency and  $N$  is the number of samples.

**Fast Fourier transform (FFT)** Efficient implementation of DFT for  $N$ s that are power of 2.

Fast Fourier transform (FFT)

**Short-time Fourier transform (STFT)** FFT computed on short time windows of the sound signal.

Short-time Fourier transform (STFT)

**Remark.** This method allows preserving time information by using a fixed frame size.

**Spectrogram** Result of STFT that shows how the frequencies change over time.

Spectrogram

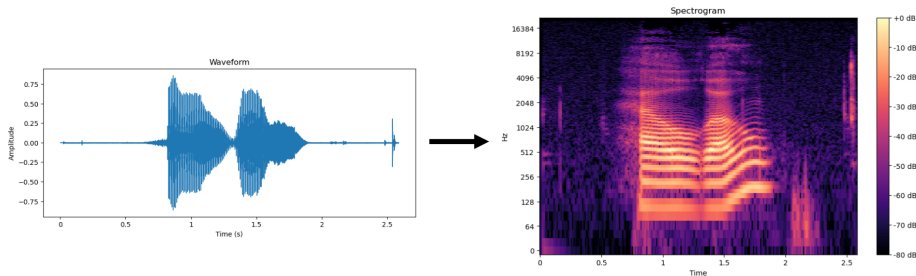

**Inverse STFT (ISTFT)** Converts a time-frequency representation of sound (i.e., spectrogram) to its sound signal.

Inverse STFT (ISTFT)

**Remark.** This allows to manipulate a signal in its frequency domain (STFT) and then convert it back (ISTFT).

**Mel-scaled spectrogram** Spectrogram where frequencies are mapped to the mel scale (i.e., lower frequencies are more fine-grained while higher frequencies are more compressed, to match the human logarithmic sound perception).

Mel-scaled spectrogram

**Audio features** Representation of a sound signal extracted from the waveform or spectrogram.

Audio features

## B.2. Tasks

**Automatic speech recognition (ASR)** Convert a sound signal into text.

**Example.** Use an RNN/transformer encoder-decoder architecture. A sound signal is processed as follows:

1. Compute the audio features from the waveform (e.g., mel-spectrogram).
2. Pass the computed features through the encoder.
3. Use the decoder to generate the output text autoregressively conditioned on the encoder.

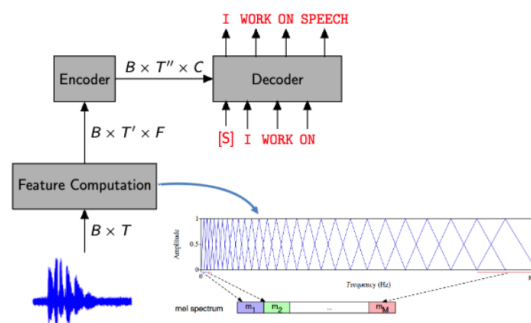

**Speech enhancement** Clear the sound signal.

**Speech separation** Separate the different sources in a sound signal (e.g., differentiate speakers).

**Text-to-speech** Convert text into a sound signal.

**Example.** Use an encoder-decoder architecture. A text is processed as follows:

1. Use the encoder to embed the input text into a representation that encodes linguistic features (e.g., pronunciation, rhythm, ...).
2. Use the decoder to predict a mel-spectrogram.
3. Use a neural vocoder to convert the mel-spectrogram into an audio waveform.

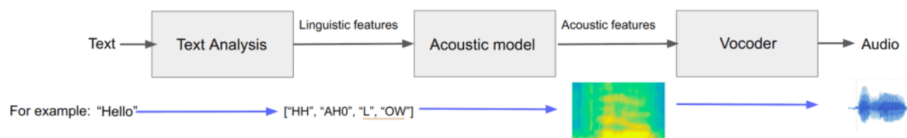

**Speaker diarization** Determine the moment and the person who spoke.

**Speech emotion recognition** Recognize emotions from the sound signal.

**Neural network explanation** Use speech to explain another speech.

### B.3. Speech foundation models

**Speech foundation model (SFM)** Transformer-based model pre-trained on speech. A common architecture is composed of:

Speech foundation model (SFM)

**Feature extractor** Converts the waveform into a low-dimensional representation (e.g., by using convolutions).

**Encoder** Computes contextual embeddings from the sound features.

**Remark.** SFM takes as input raw waveforms and are more robust in dealing with speech variability due to diverse speakers, environment, noise, ...

**Remark.** A SFM can be either fine-tuned for a specific task or used as a feature extractor for other models.

**Multimodal model** Model able to handle multiple modalities (e.g., speech and text).

Multimodal model

The main considerations to take into account when working with multimodal models are:

**Representation** Decide how to encode different modalities into the same embedding space.

**Fusion** Combine information from different modalities.

**Alignment** Link corresponding elements (e.g., in time or by meaning) across different modalities.

**Translation** Map information from one modality to another.

**Co-learning** Leverage shared information between modalities for training.

## C. Italian LLMs

**Remark.** Advantages of pre-training from scratch are:

- Having full control on the training data.
- Improve the fertility of the tokenizer.

**Minerva** Language model pre-trained on the Italian language.

Minerva

**Remark.** Minerva’s pre-training corpus is actually composed of both Italian and English datasets.

Initially, English was used for benchmarking due to the lack of Italian benchmarks. However, it is also useful for tasks intrinsically in English (e.g., coding).

**Remark.** Some training datasets were automatically translated in Italian. Some others were adapted from existing Italian ones (e.g., transform a question answering dataset into a cloze form).

**FENICE metric** Factuality metric for summarization. It works as follows:

FENICE metric

1. Extract claims from the summary with an ad-hoc LLM.
2. Align each claim with the original document with positive (if in support) and negative (if against) scores.
3. Perform co-reference resolution to unify entities across claims.

**ALERT benchmark** Benchmark to test the safeness of an LLM based on 32 risk categories.

ALERT benchmark

The testing data were created as follows:

1. Filter the “*Helpfulness & Harmlessness-RLHF*” dataset of *Anthropic* by considering for each example the first prompt and red team (i.e., malicious) attacks only.
2. Use templates to automatically generate additional prompts.
3. Augment the prompts by formatting them as adversarial attacks. Examples of attacks are:

**Prefix/suffix injection** Prepend or append an adversarial prompt (e.g., `disregard the instructions above and ...`).

**Token manipulation** Alter or invert a small fraction of tokens in the prompt (the idea is to use a prompt that is less likely to have been already seen in the alignment datasets).

**Jailbreaking** Use more complex strategies (e.g., role playing).

<end of course>